

CAST BULLETS

SUPPLEMENT NO. 1

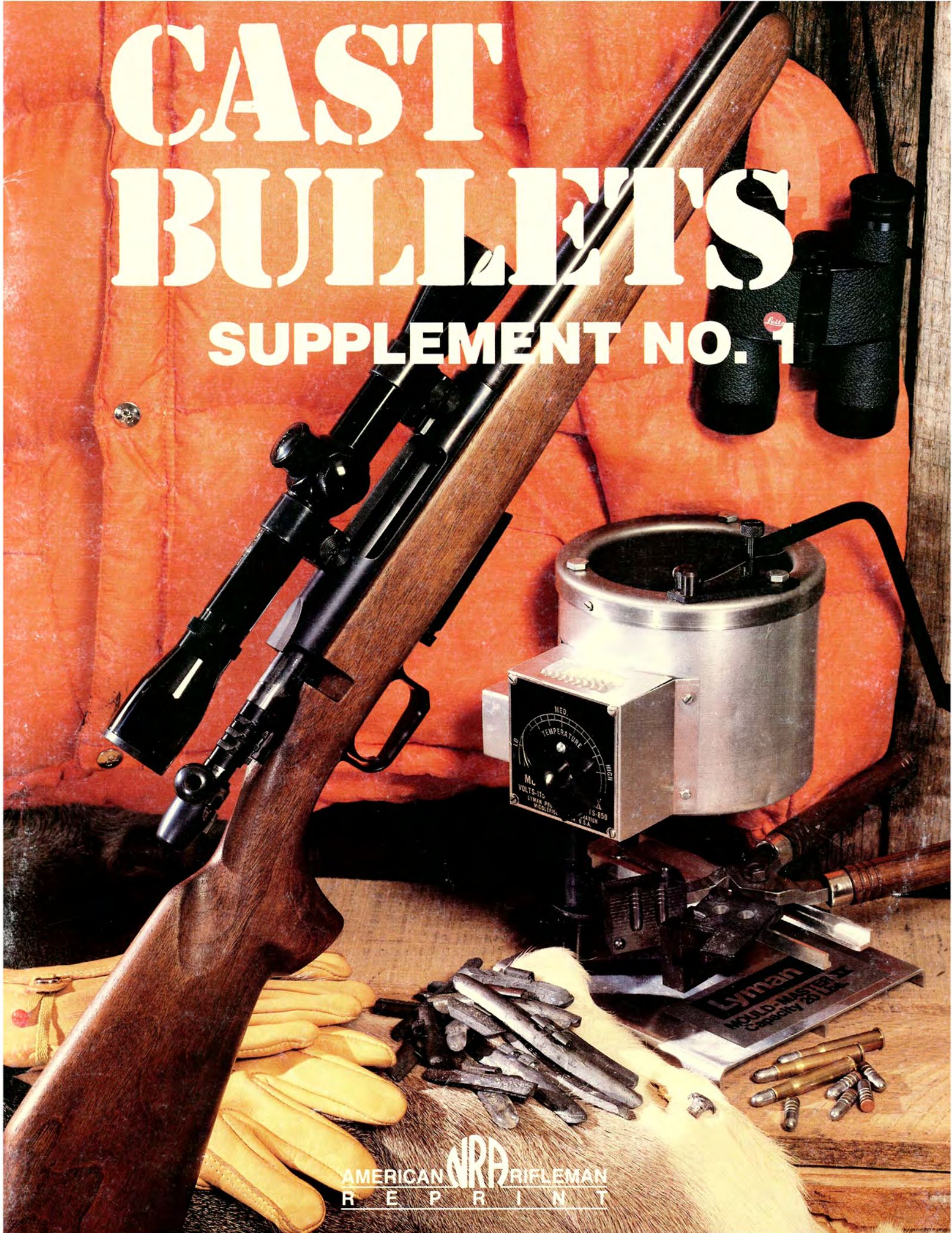

AMERICAN **NRA** RIFLEMAN
R E P R I N T



Copyright © 1981, 1987 National Rifle Association of America
First Printing, July, 1987
Second Printing, May, 1988
Third Printing, March, 1990

CAUTION: All technical data in this publication, especially for handloading, reflect the limited experience of individuals using specific tools, products, equipment and components under specific conditions and circumstances not necessarily reported in the article, and over which the National Rifle Association of America (NRA) has no control. The data have not otherwise been tested or verified by the NRA. The NRA, its agents, officers, and employees accept no responsibility for the results obtained by persons using such data and disclaim all liability for any consequential injuries or damages.

CONTENTS

Cast Bullets in Africa	
<i>On the Range</i>	2
<i>In the Field</i>	4
In My Experience	
<i>Cast Bullets in .22 Hornet</i>	7
<i>Lead Loads for Marlin's .357</i>	7
<i>Headspace & Light Loads</i>	7
Big Bore Guns and Little Gophers	8
Loading Bench — The Schuetzen Method Still Works	10
Loading Bench — An Immediate Success	11
Loading Bench — Soft Lead? A Better Way to Tell?	12
In My Experience	
<i>Reloading the .35 Winchester</i>	13
Loading Bench — A Fitted Sprue Plate	14
Loading Bench — An Easier Way to Cast Good Bullets	15
Loading Bench — Casting Pistol Bullets	16
Loading Bench — Lyman Composite Bullet Kit	17
In My Experience	
<i>.25-20 Is Still Useful</i>	18
Loading Bench — Reinventing the Manstopper	19
Loading Bench — Unique Lives Up To Its Name	20
In My Experience	
<i>Squib Loads</i>	21
Loading Bench — Handloading For .44-40 Revolvers	22
Questions and Answers	
<i>Deep Seated Cast Bullets</i>	23
<i>Paper Patched Bullet Tips</i>	23
<i>Tin-Based Babbitt Metal</i>	23
<i>Foundry Type Metal</i>	24
<i>Cavity Quality</i>	24

When George Martin packed his .375 H&H to go on safari, we decided it was a good time to test...

CAST IN

ON THE RANGE

BY C. E. HARRIS

There is little doubt that cast bullets will kill deer at moderate ranges, but little is known about how they perform on larger game except in low-velocity, large-bore, blackpowder calibers. Most .30 cal. cast bullet loads attain energies similar to the .30-30 Win. or .30-40 Krag, and good hunting practice would suggest that, for game larger than deer, hunters use either a full-power load with jacketed bullets in a suitable caliber or a large-caliber cast bullet delivering adequate energy.

When my boss George Martin told me he would be hunting in Africa, I suggested this might be a good opportunity to observe the performance of cast bullet loads on large game. He agreed, and I started experimenting with cast bullet loads in his Winchester Model 70 in .375 H&H.

Because of the nature of African plains shooting, the cast loads required reasonably flat trajectory out to 200 yds. It was also desirable to have a common point of impact for the cast loads and factory ammunition at practical shooting ranges. We were greatly concerned that the loads have adequate penetration because much African plains game is elk size or larger, and there was always the possibility of encountering dangerous game, such as cape buffalo, although for extreme situations, Martin would also have factory solids available.

While many cape buffalo have been shot with lighter rifles, experienced African game hunters consider the .375 H&H about the minimum. Medium bores are used for dangerous game only in the open, where there is plenty of time to take over a heavier rifle in case the beast doesn't fall dead on the first shot. Experienced African hunters fall into two schools of thought regarding ammunition, both of which are relevant to designing cast bullet loads for large game. Those who emphasize penetration use full-jacketed solids, making sure the bullet can smash through both shoulders to break down the game, anchoring it to the spot, even if it is not killed outright. Authorities with game-control experience shooting animals out



Author is shown preparing to fire George Martin's pre-1964 Winchester Model 70 in .375 H&H Magnum. Tests show that heat treated cast bullets give good hunting accuracy and reasonable game performance. They shoot close to the same point of impact as factory loads but are less powerful.

of a herd, however, warn against using solids when there are a lot of animals around because you may shoot straight through the one you kill, wounding others to cause trouble later. Peter Capstick

Cast bullets used in .375 H&H loads are: 275-gr. RCBS #37-250FN (left) and 311-gr. Hoch nose-pour mould #377298, (right).

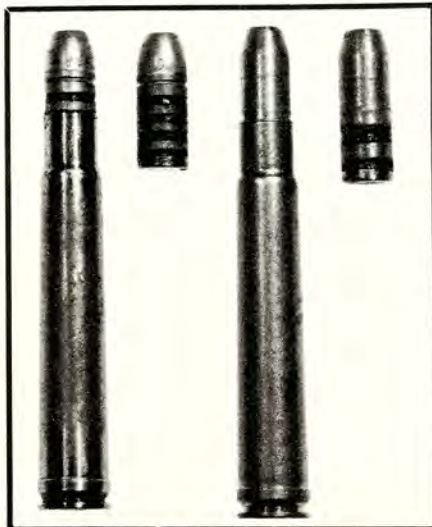

relates one such incident in his exciting book, *Death In The Long Grass*, where a cape buffalo, wounded by an exiting bullet from an earlier kill, surprised a hunting party, creating total chaos until a finishing shot took the fight out of him.

John Taylor, writing years earlier in *African Rifles and Cartridges*, also feared this happening and belonged to the second school of thought which preferred bullets NOT exit. He claimed that bullets which stayed in the animal expended all of their energy and, provided there was adequate penetration to reach a vital spot, that this resulted in cleaner kills than shots where bullets exited. Taylor felt the paper energy of cartridges was less important than having a properly constructed, heavy bullet which would penetrate deeply to reach the vitals. He considered the .400/.350 Rigby, with its 310-gr. bullet at only 2150 f.p.s. (compared to over 2500 f.p.s. for the 300-gr. .375 H&H) "fully capable of holding its own against any of the modern magnums... it can plow through an immense amount of obstruction and still remain

BULLETS AFRICA

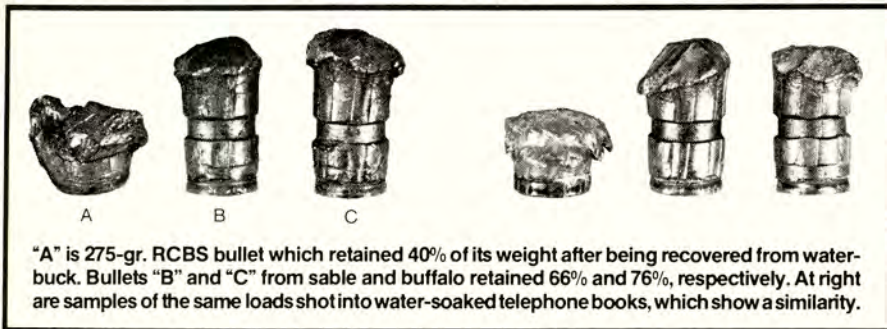

"A" is 275-gr. RCBS bullet which retained 40% of its weight after being recovered from water-buck. Bullets "B" and "C" from sable and buffalo retained 66% and 76%, respectively. At right are samples of the same loads shot into water-soaked telephone books, which show a similarity.

head-on, and has deep penetration both as a soft-nosed as well as full-patched." Most important, Taylor felt, was that the bullet stay together, since . . . a bullet that is distorted on hitting heavy bone may change direction after entering an animal

and thereby miss a vital spot, despite being perfectly placed." This feeling was reinforced by George Jacobsen, in his article, "Bullet Performance On African Game," (see *American Rifleman*, April, 1974, p. 26). After hunting with expanding bullets

.375 H&H CAST BULLET TESTS

Averages of not fewer than four rounds shot into water-soaked telephone books at 25 yds.

.375 H&H Cartridge	Vel. @ 15' (f.p.s.)	Penetration (Ins.)	% Weight Retained	Expansion (cals.)	REMARKS
Norma factory load 300-gr. Nosler SP	2512	19	78	1.70	Control Soft-Point
Handload 300-gr. FMJ Hornady bullet loaded to approximate cast bullet velocity	2185	32	99	1.00	Control Solid (some lead extruded out base opening)
RCBS 37-250FN cast of 3 lbs. wheelweights to 7 lbs. plumber's lead Heat treated to 20.1. BHN @ 9 days age wt. 275 grs.	2135	14	64	1.43	Used successfully on waterbuck and warthog. Good expansion for light game; power approximated .358 Win.
RCBS 37-250FN cast of straight wheelweights and heat treated to 29 BHN at 17 days age. Wt. 272 grs.	2153	22	76	1.09	Not used on hunt, but fired to get direct comparison of "soft" vs. "hard" HT bullets in similar loads.
Hoch 377298 cast of straight wheelweights and heat treated to 29 BHN at 17 days age. Wt. 311 grs.	2047	20	83	1.09	Used on Martin's sable, buffalo and zebra. Energy about equal to .400/.350 Rigby. Close range load for larger game.

NOTES: X-ray analysis of the above cast bullets indicated the following compositions: Nominal "1% antimony" alloy made of 3 lbs. wheelweights and 7 lbs. plumber's lead contained 1.13% antimony, 0.08% tin and 0.19% arsenic. "Straight wheelweight" metal contained 2.94% antimony, 0.3% tin and 0.24% arsenic. The arsenic content was not reduced by the dilution of wheelweight metal in the same proportion as were antimony and tin because there was a trace of arsenic in the plumber's lead used.

in Africa for several years with poor results, Jacobsen took the advice of resident European hunters and started using solids with far better results.

In designing an effective cast bullet load for Africa, we were confronted with two conflicting requirements: flat trajectory (requiring high muzzle velocity) and deep penetration. Cast bullet velocities over 2000 f.p.s. necessitate a hard bullet for good accuracy, but hunter experience indicates that bullets of linotype and similar alloys fragment severely at that speed. Although penetration of hard-cast, high-velocity .30 cal. bullets has been found adequate for light, thin-skinned game, I had grave doubts about hard-cast .375 bullets for heavier game such as sable or kudu, not to mention the possibility of cape buffalo. I felt that Martin's cast .375 loads would have to retain at least 2/3 of their weight and have penetration not less than factory soft-point .375 H&H loads. This isn't possible with conventional hard-cast bullets at velocities over 2000 f.p.s.

A means was needed to raise the velocity threshold at which fragmenting took place and to reduce the susceptibility of the bullets to fracturing. This would improve weight retention and help insure adequate penetration. In his article, "Stronger Bullets With Less Alloying," which appears in the new NRA handbook, *Cast Bullets*, by Col. E. H. Harrison, Dennis Marshall describes a method whereby lead alloys containing as little as 1% antimony can be heat treated to obtain hardness equal to linotype metal. Wheelweight metal can similarly be heat treated to half again as hard as straight linotype metal.

Marshall's metallographic examination of the microstructure of hard-cast bullets shot into wet paper at various velocities revealed that expansion of cast bullets is a



Several hundred rounds were fired in testing, but field experience emphasized need for secure crimping of bullets for hunting.

relatively smooth, continuous process which starts as an axial compression of the bullet nose, followed by shear of the displaced nose material over the perimeter of the bullet, to form the "mushroom." As this shearing progresses, a stress crack forms at the bullet perimeter which propagates in a curved path, similar to an ogive, toward the bullet nose. If adequate velocity remains as the crack grows, the expanded material breaks away, and the process starts again, continuing until the force against the nose has diminished below the level needed to sustain the deformation.

By heat treating a low antimony cast bullet, antimony particles present in the grain boundaries in the as-cast state, which contribute to the fragmenting, are put into solid solution, forming a more homogeneous microstructure which is less susceptible to ductile fracturing. Microscopic examination of sectioned, as-cast, as well as heat-treated bullets confirmed that heat treatment had removed the brittle antimony particles from the grain boundaries, rendering them less susceptible to fracture. Test firing of heat-treated bullets showed they gave good penetration and weight retention, which compared very favorably with Norma factory car-

tridges loaded with the 300-gr. Nosler Partition bullet. Firing data for the loads Martin used are shown in the accompanying table. Not shown are data for higher-velocity loads with the heat-treated bullets also tested. Although it was possible to drive the heat-treated cast bullets over 2300 f.p.s. without impairing accuracy, penetration and weight retention were not as good as at lower velocities. Following recommendations by experienced hunters, we chose penetration and weight retention over energy. While these loads are less powerful than factory .375 cartridges, they approximate the .358 Win. and .400/.350 Rigby with equal weight bullets and should be adequate for the purpose intended.

The first two loads use the RCBS 37-250 FN bullet, a close copy of the Lyman #375449, and for many years the standard cast bullet for the .375 H&H. They differ only in the alloy and heat treatment. An expanding bullet for light, thin-skinned game such as impala was made by heat treating an alloy of 3 lbs. of wheel-weight metal containing 3% antimony and 7 lbs. of plumber's lead at 480° F for four hours, 20 minutes, and fully quenching the sized, unlubricated bullets in water within three seconds after removing from the oven.

Although this alloy contains only about 1% antimony and is quite soft (about 8 Brinell Hardness Number) in the as-cast state, it hardens within nine days after heat treatment to 20 BHN, slightly softer than linotype. This is adequate to provide good accuracy up to over 2100 f.p.s., given proper lubrication. Cast of this alloy, the lubricated, gaschecked RCBS bullet weighs 275 grs. These loads, shot into wet phone books at 25 yds., when loaded to a 15-ft. instrumental velocity of 2135 f.p.s., expanded to 1.43 times original diameter, with 64% weight retention. Penetration was 84% of that obtained with Norma factory loads using 300-gr. Nosler Partition bullets.

A similar load for larger, thin-skinned game, such as waterbuck, which requires deeper penetration, was obtained by heat treating undiluted wheel-weight metal at 450° F for two hours and quenching the bullets in water, giving a 272-gr. bullet of 29 BHN after aging 17 days, almost half again as hard as linotype metal. This bullet behaved more like a "solid" and less like a soft-point when loaded with the same powder charge, obtaining 2153 f.p.s. and 2799 ft.-lbs. of energy. These bullets showed little expansion when fired into wet paper, with only minor fracturing of

IN THE FIELD

BY GEORGE MARTIN



George Martin admires the 31½" horns of his record book waterbuck, taken with cast bullet load in .375 H&H. The heat-treated RCBS bullet at 2150 f.p.s. killed the 450-lb. animal neatly, though weight loss was considerable. The recovered bullet retained only 40% of its original 275-gr. weight.

WHEN Ed Harris first suggested that I use cast bullets in Africa, I was less than enthusiastic. This, after all, was to be my first safari, filled with new experiences and new things to be learned. The last thing I needed was to be fussing around with unfamiliar ammunition.

However, the more we talked out every possibility, the more interesting the proposition became. As our test sessions at the range progressed, the idea became downright intriguing.

It is a simple fact of life that if a hunter flies on a commercial airline, there is the very real possibility that all his plans, to the minute detail, and all his careful preparation of equipment, can be dashed by the thoughtless act of a clumsy or uncaring baggage handler. A strong metal case such as made by Saf-T-Case company in Dallas, Tex., is good insurance. However, in the final analysis it is the airline's handling which can break a trip. Thus it was that I was impressed and relieved at the care and concern shown my rifles by the South African Airlines people. With four 747 flights a week from New York to Johannesburg, hunters traveling with treasured firearms are neither unusual nor a problem for SAA.

My safari was booked through International Sportsmen's Adventurers (ISA), the Chicago-based operation owned and run by George Daniels and Paul Merzig. ISA specializes in mini, two-week safaris to various parts of Africa as well as to many other parts of the world. But, don't be

the nose. Penetration, however, was 16% greater than the 300-gr. Noslers, and weight retention was very good, 76%. This load shot to the same sight setting with equal accuracy at useful hunting ranges as factory W-W 300-gr. FMJ ammunition. When sighted to strike 2½" high at 100 yds., it and the W-W solids both shot to point of aim at 200 yds. Three five-shot groups with the RCBS bullet at 100 yds. in this load averaged 1.902", with the largest group 2.14" and the smallest 1.60". We also fired a 10-shot group mixing factory 300-gr. solids, Nosler 300-gr. soft-points, and the RCBS cast load, without cleaning, and all rounds struck about the point of aim at 200 yds. in a 5.97" group. We felt this was good hunting accuracy.

The third load was intended as a close-range "stopper," using a 311-gr. heat-treated bullet of wheel-weight metal from a custom mold made by Richard Hoch in Montrose, Colo. The load we finally chose with this bullet obtained 2047 f.p.s. with 2893 ft.-lbs. of energy. Initially, we tried a heavier load giving 2220 f.p.s. There was some bore leading, and penetration and weight retention weren't as good as with the lighter load. At 2047 f.p.s., penetration was equal to the factory Norma loads with the Nosler bullets, and

weight retention was significantly better at 83%. Like the RCBS bullets of heat-treated, wheel-weight metal, expansion was minimal, though the bullets held together well and remained head-on when shooting through 1½" hardwood planks and a section of old automobile tire placed in front of a pile of wet telephone books. The main use for this load would be to "break down" heavy game at close range. If Martin felt confident with the performance of the cast loads on lighter animals and wanted to try for a cape buffalo, this would be the load he'd use.

All three loads use the same powder charge. Originally, we used 56 grs. of IMR-4064, but to get best velocity uniformity with the large amount of airspace this left in the case, a 1.0 gr. Dacron fiber filler was used over the powder. This was completely consumed on firing, giving very satisfactory results. Despite the fact that such fillers have been used without incident for many thousands of rounds in NRA tests in other bottlenecked cases such as .30-'06 and .308 Win., there have been several reports of chamber ringing when fillers were used in straight cases with relatively fast-burning powders such as IMR-4227 and SR-4759. Because these occurrences have not been

thoroughly investigated, the use of a filler in any rifle or pistol cartridge isn't necessarily recommended.

Those wishing to assemble similar loads for their .375 H&H rifles should use a powder which leaves less airspace in the case. A charge of 65 grs. of IMR-4350 will give almost identical results and does not require a filler. Minor adjustment to the powder charge may be necessary for best accuracy, although acceptable hunting accuracy can be obtained with little or no refinement of the basic load. For best penetration on large game, the striking velocity of these heat-treated cast bullets should not exceed about 2150 f.p.s.

The bullets of hunting loads should be securely crimped in any cartridges having substantial recoil. When you read Martin's accompanying article you'll understand why! Also, while target loads shoot most accurately when bullets are seated to touch the rifling, hunting loads must chamber *and extract* freely. Check *every* one! Be sure to thoroughly test any loads considered for hunting and don't settle for anything less than perfect functioning, for even with the most careful planning, Murphy's Law (that anything which can go wrong will, and will do so at the worst possible time) might spoil your hunt. ■



Cast bullet contributed to the demise of Martin's buffalo, though factory solids were called upon to finish off the beast.

misled by the term "mini"! There are only two things "mini" about these hunts — one is relative and one is absolute. Relatively speaking 10 full days of hunting is short when compared to the old, classic 30-45 day safaris. However, an absolute fact is that ISA has made the fantastic African experience affordable for other than Daddy Bigbucks. It depends, of course, on the animals you kill, but you can probably take half a dozen trophies in 10 days in the bush, sightsee for a couple of days, and spend less, including air transportation, than you would for a new Chevrolet. That's not cheap, but it is a far cry from the days when Africa was reserved for the near wealthy.

Much consultation with Daniels by

phone and letter had established that the area with the best potential for the trophies in which I was most interested was near the small town of Chiredzi in the southeast of Zimbabwe (Rhodesia). Clive Stockhill, who was to be our professional hunter, runs the hunting operation for the Hippo Valley Estates sugar cane company which owns the land and, by recent law, the game animals thereon.

The actual territory we hunted lies on the point of land above the confluence of the Chiredzi River on the northeast and the Lundi River on the southwest. The amount and quality of the game found on this site is testimony to the wisdom of the law which permits private landowners to manage and harvest their animals for trophy quality and profit.

Whether or not I would use Harris' cast bullets on buffalo would depend upon their performance on heavy but non-dangerous game. We had obviously checked and double checked both bullet-seating depth and overall length, and we had run each cartridge through the magazine, into the chamber and ejected it, not once, but several times.

We had also run numerous rapid-fire tests, emptying the magazine as fast as sighted shots would allow without the slightest hint of a problem. The old Model 70 action worked slick and smooth with all three of the selected cast bullets. The checking of zero after we arrived in camp was accomplished by single-loaded shots.

Early on the first morning of hunting we



Sable was struck nearly head-on with cast bullet, which passed almost entirely through it, retaining 66% of its 311-gr. weight.

spotted a small herd of waterbuck which contained an outstanding bull. I elected to use the 272-gr. bullet.

The herd was spooky and continuously on the move. Despite our best efforts the bull managed to stay out of range or deep in cover until the herd reached the river, which at that point was about 80 yds. wide and only 2 ft. deep.

Unlike the rest of the herd, which had headed straight across the river, the bull hesitated to give up the security of the brush on the bank. So, he turned up-river for about 300 yds. before electing to make his crossing. Although I had my position by the time he was three-quarters of the way across, Stockhill cautioned that since

Cast Bullets In Africa

there were crocs in the pool, I should let him come out on the opposite bank before taking the shot.

The bull was perhaps 10 ft. from the water and broadside heading down-river toward the herd. At the shot he spun around, staggered several steps back into the water, and dropped. I had instinctively ejected the fired case and chambered a new round.

While one of the trackers stood guard with an FN to ward off crocs attracted by blood in the water, all hands fell to to wrestle the 600-lb. carcass onto the bank. The bullet had entered low behind the shoulder, sliced the top of the heart, and stopped inside the ribs on the off side.

At this point an unforeseen problem occurred. When I attempted to empty the chamber of a live round, the bolt handle lifted easily enough, but normal pressure would not bring it to the rear. On inspection everything appeared to be in order, so I gave the bolt handle a stronger tug. Out came the case minus the bullet! With the bolt removed the base of the bullet could be clearly seen, securely gripped by the lands.

Now this is not all that unusual a situation when experimenting, but it is downright disconcerting when each and every cartridge has been run from the magazine, through the chamber, and ejected several times. Plus, several dozen cartridges with the very same components and dimensions had been fired in the same rifle without incident. The only difference was that this was done at home in Maryland some 8,000 miles away.

I tried to remember if the first loading that morning or the chambering of the next round after the shot at the bull had required unusual pressure on the bolt. None had registered, but it was unlikely I'd have noticed it while shooting at game.

Back at the truck I tapped out the lodged bullet with a cleaning rod and proceeded to lodge and unseat four more bullets in a row by action of the bolt. More pressure than normal was needed to close the bolt, but it did not seem excessive. So much for the "soft" cast bullets.

Stockhill was not the least bit enthused, asking several times if I had sufficient factory loads with me. His concern mounted when in camp three of the first five bullets I intended to use on buffalo pulled out on the first chambering. These were the hard-cast 311-gr. bullets that we had come to call "solids."

After much monkey-motion and tapping out of lodged bullets, I found eight of the "solids" which would chamber and extract repeatedly without problem. Early the next morning I fired three of these at a target without any problems. Then we went to hunt zebra.

The stallion we had located refused to

offer a clear shot. Time and again he managed to situate himself on the far side of clumps of thick brush. When he did move, he did so only if surrounded by other zebra.

Having pushed the herd for the better part of two hours, Clive began to feel that the animals were about to depart for distant parts and allowed that I had best take the first reasonable opportunity. At this point the stallion stood quartering toward me at 150 yds., partially shielded by a thin acacia bush. Through the scope it appeared I had a shot, clear of branches, at his shoulder area.

At the shot he sagged, ran 50 yds., and dropped. The 311-gr. cast "solid" had entered at the shoulder, angled back through the paunch and exited just forward of the opposite hindquarter. The edges of the exit hole were as clean as if cut with a razor, but the design of the opening was a three-pointed sawtooth, suggesting the bullet had tumbled and exited sideways.

A sable offered a different set of circumstances. At no more than 35 yds., he stood absolutely straight on. The bullet entered low in the brisket, missed the sternum, blew up the heart, and was recovered deep in the left haunch. No major bones were hit.

On noon of the seventh day, the trackers reported they had cut the trail of a herd of about 30 buffalo which contained several large bulls.

We had walked for less than an hour, a real quickie for following up buffalo tracks, when Stockhill and the trackers had a whispered pow-wow. The tracks led to a grove of low trees some 100 yds. ahead and straight upwind.

As the trackers stayed back, Stockhill and I duck walked and then crawled to within 30 yds. of the trees. We could see legs and bellies, hear munching and general moving around, but the brush concealed the heads. As we inched to the side for a better view, the herd started to drift out of the trees. At that instant, the wind swirled and every head in the herd was up and looking straight at us. They bolted en masse but were not spooked badly enough to go far, as the swirling wind had now taken away our scent as quickly as it had revealed it. Another 50 yds. of crawling, and we were again in position. Stockhill indicated a mud-encrusted bull standing broadside at the edge of the herd. From a squatting position the .375 roared. The recoil batted me into a sitting position. Instantly there were panicked buffalo racing in every direction, including ours. Stockhill was up and running, yelling "Come, Come!" He was headed for the protection of a pitifully small tree. The herd gathered and moved off. The dust settled and the area was void of buffalo, dead or alive.

"He's hit hard, but sometimes they take a lot of killing," were my guide's reassuring words. "Problem now is," he con-

tinued as the trackers joined us, "that he is very apt to try to get even."

Now it was discussion time. I had loaded 311-gr. "solid" cast bullets for the first two shots, followed by two Winchester-Western, factory 300-gr. full-metal-jacketed loads. With a wounded buffalo on our hands I would feel more comfortable with a factory solid in the chamber instead of that second hard-cast bullet which I had immediately chambered after the wounding shot. However, despite the flawless operation of the cast bullet loads on the zebra and the sable, I had misgivings about being in our current situation with a plugged up barrel as the result of attempting to replace the chambered round.

Nevertheless, I decided to make the change and in one, fluid, adrenaline-assisted motion, flipped a bulletless case out and onto the ground.

With no cleaning rod handy, the only way to dislodge the pulled bullet was to shoot it out. The Dacron fiber filler had prevented the powder from spilling out of the case when it ejected, so I rechambered the case and fired into the ground. A necessary act under the circumstances, but not one designed to instill confidence in either the professional hunter or the trackers.

As we followed the blood trail every man eye-balled every bush or clump of brush large enough to hide a rabbit — let alone 2000 pounds of vindictive buffalo.

Finally the bull found the spot from which to demand his satisfaction. Picture a gigantic greenbriar patch about 15 ft. tall, 40 ft. across, and perhaps 150 yds. long, laced with crisscrossing game tunnels about as wide as a man's shoulders and as tall as his belt buckle. The occasional splashes of blood led directly into the first entry tunnel.

Stockhill studied the situation and then announced, "I'm not going to play this silly game. Come on! While two of the boys work along the outside over there, we'll ease down this side."

About 10 yds. from the other end of what had looked to me a bit like a green, thorny quonset hut, there came a second or two of hellish thrashing and stomping. Then only a stifling silence.

Stockhill motioned me to his side and whispered, "See what appears to be a big, black log about 15 ft. back in that stuff?" I saw it.

"I think that's him lying down and waiting for us. Let's make certain."

As we continued to ease our way alongside the elongated tangle, Stockhill continued to eye his black log and just as we pulled even with it he stopped dead.

"Ha, that 'log' just flicked its ear. Shoot him," he said.

As indistinct as it had been before, now the form started to take shape, almost to materialize for me. There was the ear, now the curve of the horn, the nose, then the outline of the shoulder.

The shot spined him. He never moved from his chosen spot.

We later determined that the thrashing noise occurred as he realized that we were not on his back trail and turned to face our expected approach.

The first shot from about 40 yds. had been a little high and 18" back of the left shoulder. It broke a rib on the left side and was recovered in the right lung. The last shot was a factory Winchester 300-gr. solid which from 20 ft. entered above the shoulder at an angle, broke the spine, and stopped under the hide on the off side about midway back on the body.

A concluding note on the cast bullet loads is in order here. Despite what we thought was thorough function testing of the loads and refinement to eliminate any possibility of a "bad load" combination, Murphy's Law raised its ugly head. Discussing my experiences with Harris later, we agreed the terminal performance of the cast bullets couldn't have been better, but we obviously underestimated the importance of anchoring the bullets solidly in the case necks so they couldn't be moved even slightly. Harris found this particularly disturbing, since seating depth was checked carefully and every round run through the chamber at home to eliminate those with any resistance. There was no compression of the powder to work on the bullet; however, the reloading dies used had no crimping shoulder, and this was obviously the root of the problem.

While crimping cast bullets is an anathema to target shooters, it should be a MUST for hunting loads. Also, while target loads are often assembled so the bullet contacts the rifling when chambered, you must be willing to give up that last gilt edge of accuracy to insure easy chambering and extraction clearance for hunting loads. My rifle had a snug throat, sharp and unworn, which may have contributed to the problem, though it's now apparent that between the jostling of air travel, driving into the bush, etc., the rounds were subjected to more vibration than mixing them with factory loads in the magazine and subjecting them to the recoil of a half dozen shots fired over them. Harris feels in hindsight that a better solution would have been to apply a heavy stake crimp with a knurling tool, or a device like the old Ideal Shell Indentor into the lube groove on the bullet. We point out our mistakes here rather matter of factly in the hopes that you will anticipate and thereby avoid the problems I had. I'm still impressed with the cast bullets' performance on game, though we obviously still have some things to learn. Those wishing to do their own research might be smart to do so on animals which aren't likely to "bite back."

Whether you shoot cast or jacketed, handloads or factory, if you are interested in an African experience of your own at a reasonable price, write to ISA, 72 West Adams, Chicago, Ill. 60603, for details. ■

In My Experience

Cast Bullets in .22 Hornet

Editor:

The availability of SR-4759 again should be good news for rifle shooters who use a variety of calibers and reduced loads. I have found this very versatile powder to be excellent for cast bullets in the .22 Hornet, using the Lyman #225415, linotype metal, Hornady gas checks and Alox lube. Bullets are sized .225", and not weighed. The load of 7.8 gr. of this powder, a "suggested" one given in an old Lyman Handbook when this powder was formerly available, has given me remarkably small groups. Five-shot 100 yd. groups of 1" are common. Some are smaller, a recent one being 5/8". The bulky powder is slightly compressed by bullets seated so as to just fit the 5-shot magazine. All loading was done with a Lyman 310 tong tool using new Winchester-Western cases and Federal 205M bench-rest primers. As my previous experience with cast bullets had been disappointing with other powders, I am much encouraged by current results. Surprisingly, these groups are somewhat better than I have been able to achieve with jacketed bullets.

My rifle is a fine set trigger Walther KJ with a Leupold 2-7X 'scope. The rifle is eight years old and has fired many thousands of rounds, both cast and jacketed. It is not exactly a "bench rester," weighing only 6 1/2 lbs. with scope and sling but in my opinion, it has no peer in this caliber.

FRANK A. HALL
ORVILLE, CALIF.

Lead Load for Marlin's .357

Editor:

When I set out to try lead bullets in my .357 Marlin 1894, I did so with little hope of success. Every recent article on .357 rifles has related considerable problems with bore leading and poor accuracy up to and including "keyholing."

I used Lyman's #357446. This semi-wadcutter design weighs 160 grs. when cast of wheel weights. I size and lubricate in a Lyman 450 tool using .358 diameter Lyman dies and CBH bullet lubricant. I reject any bullets that are deformed, no matter how slight the imperfection, since experience has shown that accuracy depends upon perfect bullets. I load 14.0 grains of Hercules 2400 powder and CCI 500 small pistol primers into Winchester brass. The bullet is seated in the crimp groove with a heavy crimp. I strongly urge one to start with 12.0 grs. of 2400 and watch for excessive pressure and/or extraction problems. I have tried using light bullets (110-125 grs.) of both cast and jacketed design in the Marlin with very

little success. The heavy weight and the flat point of the 357446 are compatible with its rifling and tubular magazine.

Accuracy tests using the factory open sights and a bench rest have resulted in 3" groups at 50 yds. Sustained use of the load results in a powder-fouled bore that is easily cleaned up with nitro solvent.

C. ALLEN MCGARR
ALBUQUERQUE, N.M.

Headspace & Light Loads

Editor:

I read the article on the .35 Whelen in the Sept., 1978, *American Rifleman* with considerable interest, since it paralleled my own experiences using this cartridge over about 30 years. I have used both Springfield and Mauser actions for .35 Whelen rifles, but my first one, a 12" twist by Bill Sukalle, once of Phoenix, Ariz., is the best all-around.

It's true that headspace problems can be minimized by careful attention to chambering, so rifles just close on a 1.940" gauge, and by avoiding setting the shoulder back in sizing. However, if light loads are used, the primer blast shoves the case forward and sets back the shoulder. This happens with most rimless cases when fired with very mild loads, such as with cast bullets, and can happen even with full loads in cases like the .35 Rem., which have a very slight shoulder, and generally operate at low pressure. When reloading for rimless cases with light small game loads, this is unavoidable. I have often used 173-gr. cast bullets in my .35 Whelen with light loads, and have always had protruding primers after a few loadings, and eventually had misfires even with pistol primers.

This is not a condemnation of the fine .35 Whelen cartridge, but should serve as a caution to all handloaders who use squib loads for small game shooting, etc. Such cases must always be kept separate from those used for full power loads, since once they are used for light loads, cases will shorten in head-to-shoulder length, causing excessive headspace. This problem is most prevalent in rounds having little shoulder, but it can happen even in cases like the .30-'06 and .308 Win. when they are fired with reduced loads. Rimmed cases like the .30-30, .32-40 and .32-20 are far better for use with very light loads on a regular basis, since they headspace on the rim, and the shoulder is immaterial.

FREDERICK W. BECKERT, JR.
WEST VIEW, PA.

Big Bore Guns And Little Gophers

BY MICHAEL VENTURINO



THOUGH Montana's reputation as a hunting state rests on its game animals — elk, moose, deer, antelope, big horn sheep and mountain goat — the animal taken in the largest numbers in that state is probably the common gopher.

Because these little animals are a first class nuisance to landowners whose acres they populate, most ranchers welcome responsible persons who ask permission to hunt gophers on their properties.

Gopher hunting falls into two general categories — walking through gopher territory and shooting offhand with a .22 rimfire rifle; and shooting at long range from set positions with varmint-type rifles. I like to do both. But instead of using a .22, I like to use my favorite deer and elk rifles with special cast bullet loads.

This off-season use of my big game rifles keeps me in practice for the important meat hunting season to come; it also allows me to practice my hobby of handloading and bullet casting.

My two favorite rifles for all hunting are a Remington Model 700 BDL .30-'06 with Leupold 7.5X scope and a Winchester Model 54 .257 Roberts mounted with a Leupold 8X scope.

I picked these scopes because they have adjustable objectives and can be made parallax free, and clear at short ranges. Gophers can pop out of their holes at any range from 5 yds. on out. I limit myself to shots of about 35 yds., or less, when shooting offhand.

My first efforts with cast bullets were with the .257 Roberts and were met with immediate success. Bullets were cast in Lyman mold number 257312, sized to .257

Casting gives the author enjoyable winter evenings which provide a plentiful supply of inexpensive bullets for summer hunts.

His summertime hunts give the author a way to combine his hobbies and keep his hand in with his hunting rifles. Both the .257 Roberts, Model 54 Winchester (l.) and the Remington 700, .30-'06 are good performers with cast as well as jacketed bullets. These rifles are used all year around.



One man combines three facets of his hobby to help control these pests.



Columbian ground squirrel, locally known as gopher, is the target for the author's Winchester Model 54 in .257 Roberts. Target below shows 25-yd. grouping of .30 cal. cast bullets with gas checks attached (at left). Group at right, fired without gas checks, is unacceptable.

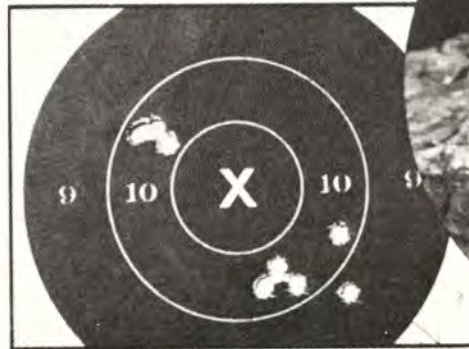

diameter, and lubed with alox/ beeswax.

These bullets were cast from straight wheelweight alloy and finished weight was 90 grs.

Loaded over 5.0 grs. of Unique, my first five rounds at 25 yds. cut one ragged hole with a velocity of 1,113 f.p.s. Thus far, with this load at 25 yds. no groups have exceeded 1/2" for five shots. Leaving off the gas checks makes no difference in accuracy.

I use Unique powder for gopher loads. Other fast-burning pistol powders would probably give comparable results, but as I use this one for several handgun car-

Because this 116-gr. .30 cal. bullet is short compared to its diameter, it casts easier than 90-gr. .25, but didn't shoot as well.

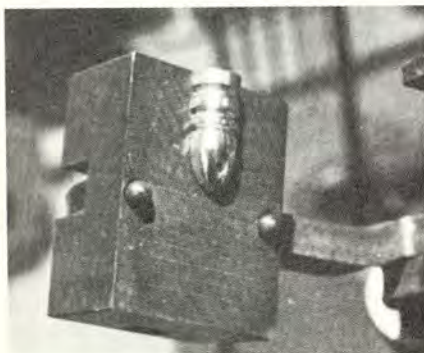

tridges, it simplifies matters to use it with my light cast rifle loads.

The Model 54 is sighted in to shoot 3" high at 100 yds., with a load consisting of 100-gr. Sierra spitzers and 49.0 grs. of Hodgdon 4831. It is 1" low and centered with the "gopher" load at 25 yds.

An added benefit from using cast bullets in my Model 54 is the wear saved on an old, much fired, but still accurate barrel.

Developing a cast bullet "gopher" load for the Remington .30-'06 was more difficult than with the .257 Roberts, but ended as successfully.

In initial efforts with the .30-'06 cartridge, I used Lyman bullet number 311257, a 116-gr., round-nose, plain base design.

With charges of Unique powder ranging from 5.0 grs. through 9.0 grs., five-shot groups measured between 1 1/2" and 2" at 25 yds. Such accuracy is not sufficient for off-hand shooting at gophers even at short ranges.

Later, I bought Lyman bullet mold number 311316 for use with a Colt Single Action Army revolver in .32-20 cal. When I tried this flat-nose, 112-gr., gas check bullet in the Remington .30-'06, accuracy immediately improved.

Using this bullet, again cast of straight wheelweight alloy, over 8.0 grs. of Unique gives 1,377 f.p.s. and groups that average well under 1/2" at 25 yds. Such a load is equivalent to the .32-20 cartridge when

fired from a carbine.

Unlike the .257 Roberts loads, if the gas check is left off these .30 cal. bullets, accuracy deteriorates with several flyers in each five-shot group.

A good friend and shooting buddy prefers magnum rifles and uses a .300 H&H and a .300 Weatherby. We have had excellent results with Lyman bullet number 311316 in both his rifles.

With their extremely low noise and recoil levels, these light cast bullet loads are useful in teaching beginners how to shoot heavy recoiling hunting rifles. Otherwise, beginners such as women or teenagers may be discouraged with first trying a .30-'06 or other "kicking" rifle.

Cost is always a consideration and not counting the time spent casting bullets and loading ammunition these light "gopher loads" rival .22 rimfire ammunition. I figure that at 1 1/2 to 2c per round, depending on caliber and variables.

A kapok or dacron filler is often recommended for cast bullet rifle loads, but my experience thus far does not indicate that this variety of cast bullet load needs a filler. This saves time when assembling handloads.

For "gopher loads," I use as light a bullet as possible for two reasons: to lessen the chance of ricochets; and to save on lead. It does not take a big bullet to kill gophers.

Guns and Gophers

In the .257 Roberts, I have tried bullets from Lyman mold number 257420 which weighed 65 grs., but I could not get suitable accuracy with them. A 90-gr. .25 cal. bullet is actually more than is needed for gophers but because it is the only mold for that caliber that I own and that casts accurate bullets, I will continue using it.

Wheelweight alloy does not cast as easily as some other alloys, due, I think, to a lack of tin. The short, blunt .30 cal. bullets usually cast OK but sometimes the longer, more slender .25 cal. slugs are not filled out completely. A little tin added to the alloy would help this but I prefer to keep things as cheap as possible, so I just cull the bad ones out as I inspect my newly cast bullets.

Bullets should be seated deep enough to cover all the grease grooves so they will not pick up dirt and grit through handling. It seems that for one reason or another some cartridges always end up in my pockets by the end of the day.

When assembling my "gopher loads," I make sure that all shells function through the rifle's magazine properly. Often gophers are spotted in pairs or even trios. It is frustrating to have a cartridge hang up when being chambered while a second target is sitting out in the open. Since not many natural rests are found in a cow pasture, all my shooting is done off-hand. I miss a lot, and I like having a quick, reliable second shot, or maybe even a third.

In gopher shooting, as with most things, having a partner adds enjoyment to the activity. It seems that many more targets are spotted by two pairs of eyes. When there are two of us the common procedure is to walk slowly side by side about 10 ft. apart. For safety, the shooter on the right takes targets only straight ahead or to the right, and the fellow on the left shoots only straight ahead or to the left. No shooting across the front of the other shooter is allowed.

For possible use on rattlesnakes, I usually carry a handgun loaded with shotshells. So far I haven't had to use it.

During hunting season while after big game I carry several of my "gopher loads" in coat pockets. If I spot a grouse, I can shoot it without the noise scaring any other game entirely out of the area.

Although I have never had to do so, these light loads could also be used to finish off a downed animal without ruining precious meat. However, my favorite use for light cast bullet loads is in the gopher fields. It is challenging and fun to slowly walk along taking offhand shots at targets of opportunity. I think using my big game rifles this way in the off season will make me a better marksman when the loads are full power and the quarry is trophy material. ■

From The Loading Bench The Schuetzen Method Still Works

Breech Seated Cast Bullets Break A 77-Year Old Record



Welsh's 10-shot group (right) at 200-yds. measures .521". The Rowland group (above) fired May 16, 1901 measures .727".

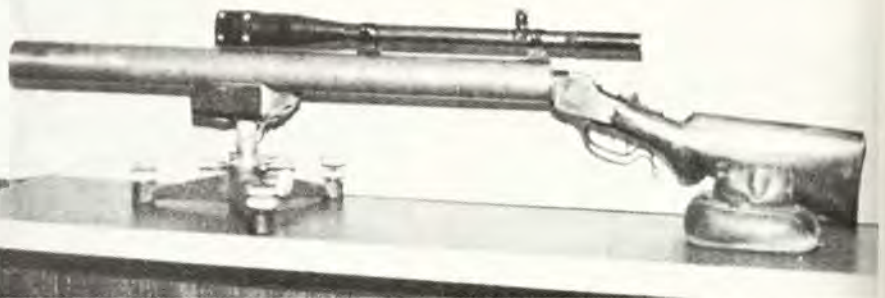
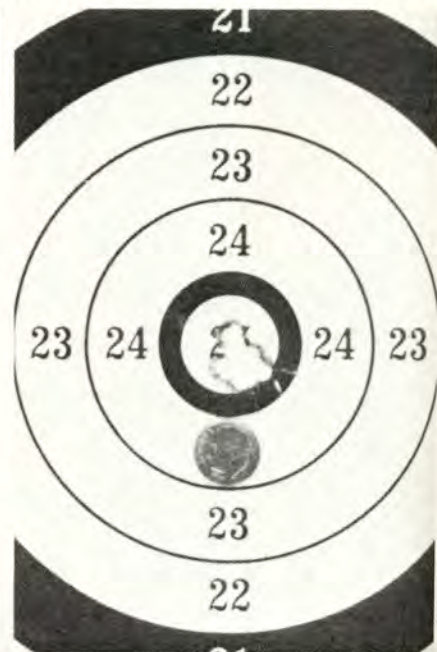

Welsh's Winchester highwall action has original Schuetzen double-set triggers and shotgun-type buttstock. The .32-40 barrel is 2.5" in diameter, 30" long and weighs 30 lbs. It has eight lands and grooves with a 15½" twist. The scope is a 24X Redfield Model 3200.

NEARLY every handloader interested in precision rifle shooting has heard of the Rowland group. On May 16, 1901, Charles W. Rowland of Boulder, Colo., fired 10 shots from his Pope-barreled .32-40 Ballard rifle to produce a 200-yd. group measuring .727". This stood as a cast bullet record until May 21, 1978, when James A. (Bud) Welsh of Kenmore, N.Y., fired a 10-shot group at 200 yds. which measured .521".

That the Rowland group stood as the 200-yd. cast bullet record for 77 years speaks for itself. More amazing, it was unequalled by the best jacketed bullet ammunition in the most modern rifles for over half a century.

Welsh, a 34-year-old machinist and model maker, has been an NRA Member

since 1955. He began competing in rifle matches in the early 1960s. His interest gradually became centered on the matches sponsored by the American Single Shot Rifle Association, where he has participated since 1971.

The American Single Shot Rifle Association fosters and preserves shooting classic falling block rifles with the traditional ammunition and loading procedures used at the turn of the century. Only cast lead bullets without a gas check are allowed. Breech seating of the bullet in the throat before loading the powder charged cartridge case is permitted.

Welsh's .32-40 Winchester highwall rifle was fitted with double set triggers and a 24X Redfield 3200 telescope. The eight-groove barrel was rifled by Kenneth R.

From The Loading Bench

AN IMMEDIATE SUCCESS

James A. Welsh made this mold to cast a two-diameter (.322"-.3245") flat point, base cutoff lead bullet weighing 200.5-grs.



Breech seating the bullet. After the guide tool is removed, the powder-charged cartridge case is chambered behind bullet.

Bresien of Warsaw, N.Y., with 15½" twist. Bore and groove diameters are .3155" and a .3232" respectively. It was chambered to Welsh's specifications with a .3215" diameter cylindrical throat behind a 10° included angle forcing cone. Measuring 30" long and 2½" outside diameter, the barrel alone weighs 30 lbs.

Welsh made his own base cutoff mold for a two diameter bullet. The four front bands measure .322"; the base band .3245". Cast of 20 parts lead to one part tin from a Lyman electric bottom-pour pot at 800° F, it weighs 200.5-grs.

The bullets were lubricated with a mixture of half Vaseline and half paraffin to which had been added one teaspoon of RCBS case lube per pound of mixture. They were seated into the throat using a Roderick-type concentric chamber guide so that the base was 2.125" forward of the breech. A single W-W .32-40 cartridge case was primed with Remington 2½ pistol primers and loaded with 14.6 grs. of Du Pont IMR 4227 powder, then chambered without an over powder wad behind the breech seated bullets which were shot in the order they were cast. Estimated muzzle velocity is 1425 f.p.s.

The record-breaking group was fired at a shoulder-to-shoulder match sponsored by the Western New York Schuetzen Society at the Alabama Hunt Club range. An overcast sky, 65° F temperature and 5-10 m.p.h. winds from four o'clock prevailed during the match which was fired for score on the official American Single Shot Rifle Association target.

It took Welsh about 15 minutes to fire the target. He told me that one of the hardest things he has ever done was to touch off the set trigger for the last shot in the group. — CLAUDE E. RODERICK



Remington 40X rifle with 26" Hart barrel and 24X Leupold scope weighs 16½ lbs. The cast bullet is loaded in .308 Winchester cases charged with 24 grs. of Hercules Reloader 7 powder and Federal primers. The 45 consecutive record shots hit a 1" circle at 100 yds.

CAST bullet accuracy is a sometime thing. Success which comes without lengthy load development is a memorable event. This is the story of one such happy occurrence.

A flat-point bullet designed by Sidney Musselman, secretary-treasurer of the Cast Bullet Ass'n, shot only fairly well in his .30 cal. rifle. After a brief conference, we decided that its 1.17" length was a bit too long for the bullet to be well stabilized in his 14" twist barrel at achievable velocities. I immediately accepted his offer to loan me the mold to try the bullet in my .308 Win. rifle having a 12" twist.

Cast of linotype, the bullet dropped from the Hoch point-cutoff mold weighing 188.5 grs. After seating a Hornady gas check and filling the grooves with Alox Accu-Lube lubricant, the ready-to-load weight is 193 grs.

Remington BR cases with Federal 205 primers were loaded with 24 grs. of Hercules Reloader 7 powder, a charge which I find shoots well most gas check cast bullets weighing from 170 to 210 grs. Muzzle velocity is from 1900 to 2000 f.p.s., depending on the case and primer as well as the bullet used. This combination gave an instrumental velocity at 15 ft. of 1913 f.p.s. For the first trial on May 10, neither the bullets nor the powder charges were weighed. The bullets were sized in a .311" RCBS die and seated to touch the rifling lands.

Success came immediately. Only four shots were fired to zero the 24X Leupold scope on the Hart-barreled Remington 40X rifle at 100 yds. Five consecutive five-shot groups then measured .70", .81", .49", .92" and .91", giving an average extreme spread of .766". Every one of the 25 shots hit the 1" diameter 10-ring.

Encouraged by this, I loaded more for a Cast Bullet Ass'n-sponsored match held

May 24-25. The cartridges were loaded in exactly the same way, but this time the bullets were selected from those which weighed within ±0.1 gr. Good shooting conditions prevailed on the first day's matches at 100 yds. The load continued to shoot well and my aggregate score for four, five-shot targets was 200-6X. Counting the targets fired two weeks earlier, this made 45 consecutive record shots all striking a 1" ring at 100 yds.

The gentle rain which fell at dawn the

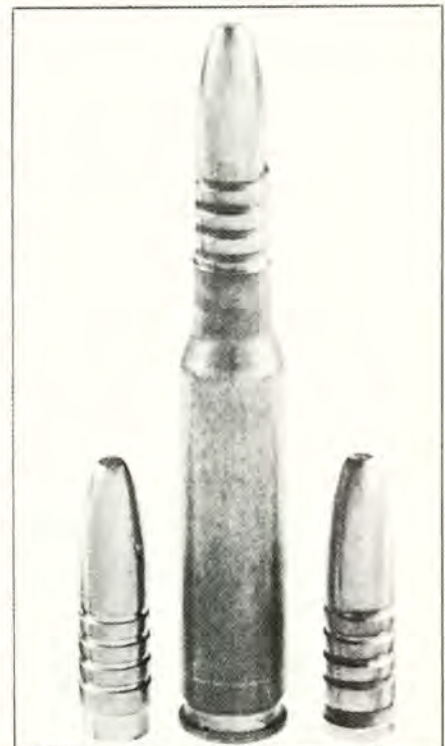

Bullet loaded in .308 Win. case is shown as cast (left). With gas check attached and lubricated (right) it weighs 193 grs.



Five-shot group at 100 yds. measures .49" between centers. Target shown actual size. The first 5 100-yd. groups averaged .766".

next day did little to dampen my spirits. Changing weather conditions concerned me more. By the time the first 200-yd. match was fired at 9:30, the skies began to brighten, and I had lost my first point. One shot missed the 2" diameter 10-ring by about 1/16". Before noon, another had leaked out by even less, leaving my 200-yd. score 198-12X. Of a possible 400, the grand aggregate for 100 and 200 yds. stood at 398-18X.

Thus, five new Cast Bullet Ass'n records for open class rifles were set in two days. This includes the 100- and 200-yd. aggregates, and the grand aggregate of the two. The best single target at 100 yds. scored 50-3X. The best at 200 yds. scored 50-5X, each of the five shots striking the 1" diameter X-ring.

Target shooters, as well as hunters, considering the significance of these results, should know that each shot in the matches was fired on a separate target. Also, the 16½-lb. rifle was removed from the rests after every shot (elevating the muzzle positions the powder charge uniformly in the case). Only two shots fell outside one-half minute of angle from its intended point of impact. The worst of the 65 consecutive record shots struck 1.219" from the target center at 200 yds.

Richard Hoch, Rt. 1, Box 507-B, Montrose, Colo. 81401, made the mold. The identification number stamped on it is 312190-730.

I'm happy with my final score. While the possible aggregate was not realized, the two misses were out by so little that I'm convinced a perfect 400 is attainable. I have designed another point-cutoff .30 cal. cast bullet which I believe will do it.

ROBERT N. SEARS

The widest record shot shown here struck 1.219" from the target center at 200 yds. On one target, all five hit the 1" X-ring.

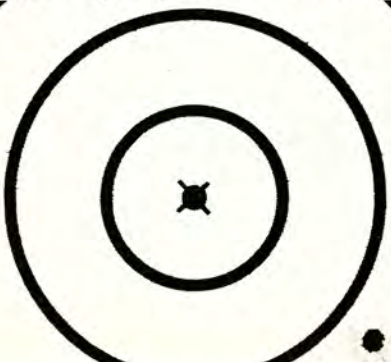

From The Loading Bench

Soft Lead? A Better Way To Tell?

BLACKPOWDER shooters use either pure lead or lead with only a few percent tin added for casting their round and Minie balls. Lead used for bullets in blackpowder guns should be as pure as possible, since small amounts of antimony can increase hardness enough to affect the obturation (base expansion during seating) of Minie bullets, increase loading effort of round balls, and make their performance erratic. Traditionally, shooters have determined the suitability of lead for bullets by testing it with their thumbnail. If the metal was easily scratched or dented, it was "soft"; if not, it was "hard." The thumbnail hardness test is not a reliable indicator of the hardness of lead alloys. (See *American Rifleman*, July, 1977, p. 59.)

Pure lead has a Brinell Hardness Number (BHN) of 4.0, whereas "plumber's lead," the most common source of lead for bullets in blackpowder firearms, can range as high as 5 BHN. However, the thumbnail can easily mark metals up to about 11 BHN, more than twice as hard as pure lead. Such harder metals may not give reliable obturation of the base cavities in Minie bullets, except with heavy charges, and don't give best accuracy with patched balls.

There is a better way for blackpowder shooters to determine the usefulness of bullet metal. Heat up the metal in your casting furnace, insert a lead thermometer (Brownell's sells such a device for about

\$18; Marmel Products has one for about \$35), and turn off the casting pot. Record the temperature at one-minute intervals. Pure lead will freeze only like the two plots shown in Fig. 1. These curves show the metal will either lose heat immediately (Ohio Thermal — RCBS curve), or if the heating element is hotter than the metal (Lee curve), within the first few minutes. From there on, the metal temperature can never again rise. If it does, you've made a reading error. To avoid such a problem, simply position your eyes exactly and reproducibly in front of the thermometer each time a reading is made.

The freezing of pure lead has three distinct phases. On the left of both plots in Fig. 1 is liquid metal cooling. In the middle is pure lead freezing, which occurs at 621°F, and on the right is solid metal cooling. Pure lead always freezes at this constant temperature. Any deviation whatsoever from a flat horizontal line in this central portion means either a reading error (explained above) or that the metal wasn't pure lead. Thus, once you've mastered reading your thermometer, you can spot pure lead's freezing curve easily.

Another point about Fig. 1 is worth noting. The length of time it will take for pure lead to freeze (horizontal section of plot) is determined primarily by how much metal you're using. Thus a 22-lb. (10-kilogram) load will take much longer than a 10-lb. load. There are slight differences between furnaces of equal capacity due to

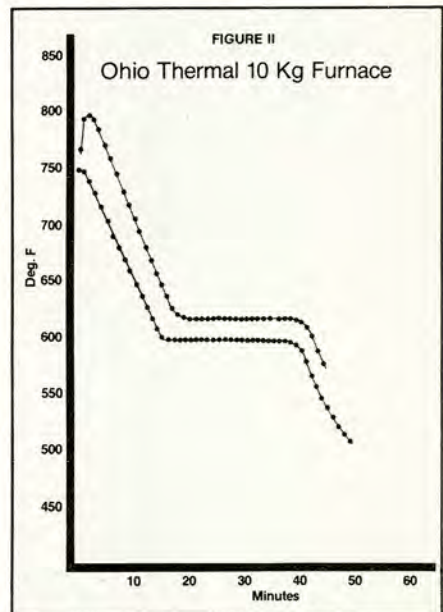
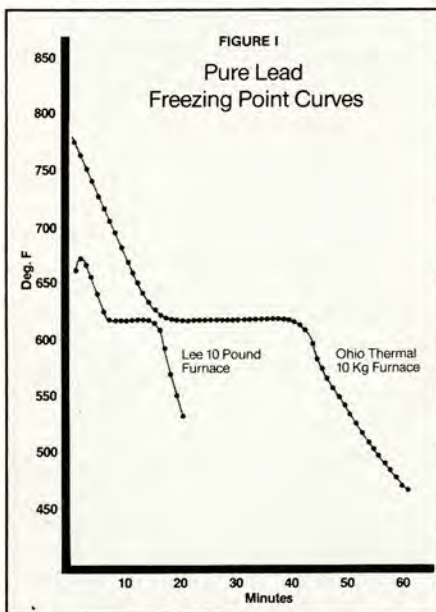

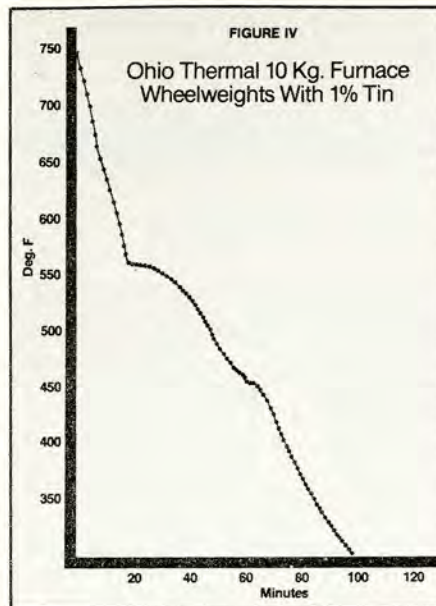
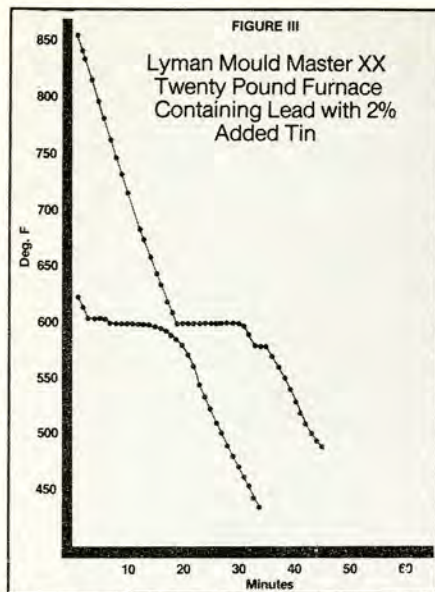

construction (heat retention) variations, but these are minor. Any furnace using at least 10 lbs. of metal should work nicely.

Suppose you get curves like those shown in Fig. II. Clearly the upper line is pure lead. The left side shows that there was a little heat transfer from the furnace after it was turned off, but after that, normal liquid cooling occurred. At the 20-minute mark, pure lead freezing set in and continued for the next 19 minutes. Finally, we see the beginning of the solid metal cooling.

The lower graph is virtually identical except that the flat portion occurred at 600°F. A curve with a shape resembling the freezing of pure lead, but which has a plateau displaced above or below 621°F, suggests a thermometer which is reading incorrectly. As we shall see later, the cooling curves for alloys are much different in shape.

Thermometers, like any instrument, will occasionally need adjustment. All you need to do is to immerse the probe of the device in pure lead, remove its glass face, and reset the dial so that it indicates 621°F when immersed in pure freezing lead. Sooner or later this will have to be done, but fortunately it's very easy.

Some, perhaps most, blackpowder shooters use pure lead for their projectiles. Suppose, however, that you want to improve the casting qualities of your metal. One way is to increase the furnace temperature, because the hotter the lead is, the better it will flow and the better your molds will fill out. The problem with this approach, however, is that the metal will develop more dross, some of which may find its way into your bullets.

There are two ways to avoid this difficulty. First, a bottom-draining furnace will deliver hotter metal to your mold than a dipper with no increase in furnace temperature. This is because less heat is lost between the furnace and the mold.

The second way to improve metal flow

is to add up to 2% tin to your lead. Small tin additions have very little effect on hardness — and as little as 0.25% greatly reduces the oxidation which interferes with metal flow. This promotes better mold fillout, and, as far as I can tell, doesn't affect accuracy. Fig. III shows two plots of 98% lead 2% tin alloys. Note how the central flat portion disappeared in both cases. On the left curve, instead of one central flat portion, there are several. On the right plot there are two distinct flat portions rather than one.

Fig. III simply tells you that you don't have a pure metal. It provides *absolutely* no indication of what you do have. A small percentage of dozens of possible contaminants could yield the same basic curves. Thus, this technique will identify pure lead only. It says nothing whatsoever about composition of alloys.

To further illustrate this important point, consider Fig. IV. This curve represents the cooling of a furnace load of straight wheelweights. On the left is liquid metal cooling. On the right we see solid metal cooling. What's going on in the middle, however, is the freezing of a complex, undetermined mixture.

You could have your metal analyzed to determine whether or not it's pure lead, but from my own experience, I can tell you that most metal determined by the method described will be essentially pure. If it is, and your thermometer is working correctly, you'll get a curve that looks like those in Fig. I with a flat at 621°F. If you get this shape but the flat portion occurs at a slightly different temperature, immerse the thermometer in known pure lead and make sure the flat portion occurs at the proper temperature. If it doesn't, adjust the thermometer. Finally, and most important, remember that this technique will easily spot pure lead. It tells you *absolutely* nothing, however, about the composition of anything else. — KENNETH L. WALTERS

In My Experience

Reloading the .35 Win.

Editor:

Winchester 1895 lever-action rifles for the .35 Win. still make effective big game rifles, despite the fact that factory ammunition is no longer available. Handloaders can make satisfactory cases for reloading by charging primed .30-40 Krag cases with 12 grs. of Hercules Red Dot powder and wadding them with toilet tissue or cotton. Firing this blank in the .35 Win. rifle will form it to the chamber. Cases made in this manner are about 1/10" short, but work satisfactorily.

These fire-formed cases are then neck sized only using a .35 Whelen, .358 Win. or .35 Rem. sizer die. If cast bullets are used, the case mouth should be expanded slightly using a stepped Lyman "M" die, RCBS cast bullet neck expander, or a suitable hand tool such as the Lee cast bullet neck expander. The flared .30-30 neck expander plug of the old Ideal tong tool works OK, too, as does a .38 Spl. expander plug.

The .35 W.C.F. cartridge is longer than the .35 Rem., so if this caliber seating die is used, both the seating stem and the die body must be backed off to obtain a correct overall cartridge length not over 3.15". Seating dies for the .358 Win. or .35 Whelen are more convenient to use here. Of course, if you wish, .35 Win. dies can be had from RCBS, though improvised dies work just fine if you need only a few cartridges.

The .35 Win. can use any .357-.358" jacketed bullet not over 250 grs., and the various .38 Spl. and .357 pistol bullets also work fine for small game or plinking loads. Appropriate charges for hunting loads are 42 grs. of IMR-4895 or IMR-3031 with 250-gr. jacketed bullets, for about 2000 f.p.s. With 200-gr. jacketed bullets, try 44 grs. of 4895 or 3031 for about 2200 f.p.s. Most of the jacketed 158-gr. .357 pistol bullets give satisfactory accuracy with 15-20 grs. of #2400 or IMR-4227, giving velocities from 1200-1500 f.p.s. Lead pistol bullets of this weight are better with lighter charges of 7-8 grs. of Unique for 1000-1100 f.p.s.

The .35 Winchester is still an effective hunting round, and the 1895 lever-action is fun to shoot, once you find a way to feed it.

ROBERT Pearl, ST. PAUL

From The Loading Bench

A Fitted Sprue Plate

A small pouring or "sprue" hole in the bullet mold cut-off plate makes a better base on the bullet, and also makes the plate easier to knock around in cutting off the sprue ("Sprue Hole Diameter," *American Rifleman*, Nov., 1971, p. 89). There are, however, considerations which favor a larger hole.

As the above reference pointed out, a large hole produces bullets better filled out. The reason, not explained there, is that the mold must fill very rapidly if the bullet is to form without defects. A too-small hole allows the slowly-moving metal to solidify irregularly against the cavity wall.

An additional consideration should have been mentioned. It arises from the slight shrinkage as the metal solidifies. All practicable bullet metals shrink in solidifying, and this includes type metals despite a long-held belief that they expand ("Solidification Shrinkage," *American Rifleman*, Dec., 1966, p. 88). The sprue being narrower than the bullet, it unavoidably freezes before the bullet can become fully solid. The effect is greatest with a small sprue. Large bullets cast with the usual all-purpose sprue plate thus contain a teardrop cavity near the base. This is quite visible in photographs of such bullets when they are sectioned ("Casting Large Bullets," *American Rifleman* April, 1958, p. 88). Even in small bullets there must be some effect. Assuming the casting dipper is left connected to the mold so long as it is still feeding the bullet, as it should be, any cavitation is on the

bullet axis where it is of little consequence. Nevertheless, the irregularity is undesirable.

Bullets can be sorted by weight, but in my experience weighing well-cast bullets has meaning with only highly refined loads. A good sprue hole is one which is as small as it can be made while producing bullets which are practically perfect to visual inspection, including the base around the sprue imprint. In practice this means a hole half the bullet diameter, or with care one-third. The smaller hole requires quality bullet metal and great care in casting. The bullets should be inspected rigorously. Some experienced handloaders do not always do this, and I have seen some cast bullets which were almost incredibly bad.

The sprue holes in seven Lyman mold cut-off plates were found to average very near .150" diameter. This is a good size for bullets of .30 cal. and somewhat larger. (The holes in these factory plates often have been made with very dull edges, which cannot cut off hard alloys cleanly.) The .150" diameter is too small for very large bullets and too large for very small. On a mold for the Lyman No. 451121 bullet of 475 grs., enlarging this sprue hole to .218" greatly improved the quality and ease of casting this big bullet. At the other extreme, a .150" sprue is almost as large as the whole base of a .22 cast gas-check bullet. Unless it is well centered, it may even run off the base on one side.

The above considerations apply

primarily to large and long rifle bullets, which are always harder to cast in best quality than the short bullets of handguns. But these factors do affect handgun molds and bullets also.

The greatly enlarged sprue hole of the No. 451121 mold required attention to the corresponding part of the casting dipper. Three Lyman dippers, two of them new, had pouring holes averaging .180" diameter. This was quite inadequate with the enlarged plate hole. So the pouring spout of one dipper was enlarged to .235" for use with the .218" plate, and worked well. It should be remembered also that the dipper spout tends to become constricted by dross.

After consideration, the dipper with this enlarged opening was tried thoroughly in casting .30 cal. rifle bullets with a .150" sprue hole in the mold plate, and produced distinctly better bullets than a standard dipper. That is what should be expected; it is not reasonable to put the melted alloy through a narrow passage which throttles and cools it before it even reaches the mold. I believe therefore that a contact dipper should deliver metal in full quantity and heat to the mold plate, which controls its entry. This means a dipper pouring hole much larger than the hole in the cut-off plate.

Molds which fill and cut off at the bullet point eliminate any bullet base problem—though these molds still will require the correct sprue and dipper openings whether that is appreciated or not. Experience has shown that imperfections at the bullet point have less effect on accuracy than imperfections at the base. Good as this bullet type is, however, it is not for every cast bullet shooter. The necessary wide nose flat so increases air drag in flight that most useful muzzle velocities are limited to about blackpowder levels (not that this is always bad). So the point cut-off bullet is a special form for maximum-accuracy shooting at only moderate range and velocity, for which the Schuetzen riflemen developed it.

These effects of sprue size in both mold and dipper apply to all bullet molds. Apparently they have never been described clearly before. Putting this information to use requires only enlarging the dipper pour hole, for medium caliber bullets (for which the usual plate hole size is suitable as it is), and for large calibers enlarging both dipper and plate openings, as described. The user can do this himself or readily have it done locally. These simple changes bring a highly worthwhile improvement in both bullet quality and casting ease. Small caliber molds are likely to need a new plate with a correctly proportioned small hole.—E. H. HARRISON



Dipper at left has hole enlarged to .235" for casting large bullets. Factory mold plate at top has regular .150" sprue hole for casting medium diameter bullets. Plates made of $\frac{3}{16}$ " ground flat tool steel below have .159" and .096" holes for medium and small caliber bullets (plate with enlarged hole not shown). Plates of hard aluminum are better.

From The Loading Bench

An Easier Way to Cast Good Bullets

A bullet mold, to reloaders who just want to cast bullets of reasonable quality, is simply a mold. On the other hand, there are some reloaders who want a perfect product, who are seeking tighter groups, higher scores, and more satisfaction than is provided by simply hitting a can or keeping them all in the black. I belong in the latter group.

On top of the list of highly valued qualities which all bullet molds *should* have is the ability to cast a perfectly round bullet with its base square to its axis. The mold should also be easy to operate, with cavities smooth and free of burrs to allow bullets to drop free when the blocks are opened.

Bullets that are of uniform weight can be obtained through proper casting techniques, use of an alloy that flows well to make full impressions of the mold cavity, frequent fluxing and a correct casting temperature, preferably not over 750°F, which will fill the mold, while minimizing loss of tin and antimony through oxidation. A mold cavity can only hold so much metal, and proper casting by making a large sprue and keeping the sprue liquid as long as possible to minimize shrinkage voids in the casting will result in .30 cal. bullets that sometimes vary only $\pm .2$ grain out of the mold.

An article by George L. Jacobsen, former Assistant Superintendent, Frankford Arsenal, (*American Rifleman*, July, 1958, p. 30), summarized the factors affecting accuracy by saying "bullet quality is, by far, the most important factor." After shooters get through with all their mumbo-jumbo and the bullet departs the muzzle, out of their control, it is only those projectiles that are nearly perfect that arrive at the target where desired and expected.

As reported by Claude E. Roderick in *Precision Shooting*, Nov., 1977, cast lead bullets, in proper loads and suitable rifles, will group with the famous bench-rest guns of today. Roderick tells of Mr. James A. "Bud" Welch's shooting 100 vds., 5-shot groups, bench-rest, of .103", .081" and .069" with a .32-40 Darr-barreled Winchester High Wall, single-shot rifle. This indicates that outstanding accuracy is indeed possible with cast lead bullets if we can only find the way.

I find it necessary to carefully in-

spect every new mold I receive. There are many problems in casting I can avoid if I work the blocks over before heating up the lead pot.

Out-of-round bullets mean poor accuracy, so I wipe the blocks clean of oil and, with magnifiers, check for light coming through between the blocks. If there is a gap, look for tiny burrs along the edge of the blocks that will hold the blocks apart. Carefully stone the burrs away and again check for light. Recently, when examining a new RCBS mold, I found the left side of the slot cut in the sprue plate for the stop pin, cammed the blocks open a hair, and light could be seen. By filing away the metal on the sloping side of the notch, allowing the stop pin to hit in the middle, the gap between the blocks was eliminated.

Holding the blocks with both hands, and the seam towards you, rotate the left block back and forth and at the same time rotate the right block in the opposite direction. If there is movement of the alignment pins in their mating holes, you should be able to feel and see such movement. Look hard at the cavity in the block to see if one side is out of line with the other.

Should there be movement in the blocks, as above, it may be because the rounded ends of the pins are not firmly engaging the holes in the opposite block. Drive the pin(s) further out of the block and again check for movement and alignment. Don't get too tight a fit, as it will be difficult, if not impossible to pivot the blocks apart when casting.

After use or abuse, the holes in the face of the block into which the alignment pins go will wear or turn up a burr. This burr will hold open the blocks (look for light) and produce an out-of-round bullet. Stone away the burrs with a flat oil stone, then bevel the holes slightly.

So far I have treated only the problem and corrections for molds casting out-of-round bullets. Now I will list other checks to make in the interest of getting better bullets.

1. Be certain vent lines are open into the cavity by tracing them with a sharp, narrow instrument, such as a tiny Swiss knife file. Check both sides of the cavity and both blocks. Generally, two sides of the cavities will be clear and two sides obstructed by metal burrs turned up by

the cherry. This will prevent air from escaping, which will produce a bullet with a rounded band. Burrs also tend to make the bullets stick in the cavities. Clean out such vents carefully, and very lightly stone the faces of the blocks afterwards.

2. Using a piece of flat steel or plate glass and 400 grit paper, polish the top of the blocks and the bottom of the sprue (cutoff) plate.

3. Adjust the plate so that it lies firm but flat against the blocks, and so that it turns smoothly without galling. Don't snug the sprue plate pivot down too tight. When casting, let the sprue harden fully so it will cut clean without tearing, or smearing metal across the blocks to force the sprue plate upward, causing fins on subsequent bullet bases.

4. Make certain that handles do not contact blocks except at pins. At times, blocks are held open because they cannot pivot fully on the pins.

5. From time to time as you cast, examine the inside faces of the blocks for flecks of lead that will hold the blocks apart and produce oval bullets.

6. When casting, keep the sprue plate swung open until the blocks are closed. If this is not done, the left block and sprue plate will droop and sometimes strike and raise a burr on the right block, or damage the right bullet cavity.

7. If bullets do not drop free (especially with linotype) look for multiple mold seam marks on bullets from the offending cavity. Lap the cavity to remove burrs in the cavity or vent lines, and the problem should cease.

Near perfect bullets can be made and accuracy thereby improved, but one must be aware of the problems and know the solutions. If you are a seeker of the perfect group, you face many problems in getting a concentric cast bullet with a square base. Some of these problems can be minimized if your bullets are marked to index 12 o'clock as they come from the mold. Mark them on the nose by putting a small prick punch mark on the inside of the cavity, or by filing a tiny notch on the edge of the cavity near the nose. This will leave a small bump which serves as a reference to orient the bullet throughout the sizing, loading and firing process. It is removed easily with the thumbnail before firing and does no harm. Upon inserting the cartridge in the chamber, keep that mark in the same place each time (12 o'clock). If there are errors in your bullet concentricity let them be delivered to the rifling at the same place each time.

Now go shoot that quarter-inch group.—E.L.

From The Loading Bench

Casting Pistol Bullets



Shooters unwilling to exercise the time and effort needed to cast and select good bullets should rely on factory swaged or jacketed ones instead, but the patient, careful caster can do well with a bottom-pour pot and 4-cavity mould, making suitable bullets for most practice and competition.

BULLET casting is not the awesome task it might seem to the novice. You can learn to cast good practice bullets in a short time, and experience makes the task easier and the product better.

Although single-cavity molds are adequate for the occasional shooter, the target shooter needs a higher production rate than the single cavity provides. Double-cavity or four-cavity molds are reasonably priced and serviceable.

Casting should always be done with good ventilation; outdoors is ideal. In the winter I cast in my basement in front of an open window with an exhaust fan running the whole time and another window cracked for draft.

A gas stove, such as a single-burner Coleman, used with a cast-iron pot and dipper works satisfactorily for bullet casting, but I prefer an electric furnace which permits controlling the temperature. Bullet alloy deserves some consideration. Uniform, repeatable accuracy from batch to batch of handloads requires bullets of the same weight, quality and hardness. Therefore, you must find an alloy which casts well and which you can duplicate time after time. Although revolver bullets loaded below 800 f.p.s., as for .38 wadcutter ammunition, can be made of almost any alloy which will cast well, automatic pistol bullets must have suitable strength and hardness to avoid leading in the shallow-groove rifling of .45 automatic pistols and to minimize feeding problems caused by the bullets' stubbing against the feed ramp.

The minimum hardness which I have

found completely satisfactory for .38 or .45 wadcutter loads for use in automatic pistols is about 12 Brinell Hardness Number. This is the hardness of straight wheelweight metal of current composition.

Once wheelweights are cleaned and remelted, it is usually necessary to add additional tin to get good castings. As little as 1/2% will do if you keep the pot temperature below 750°F to minimize drossing and if you don't cool down and subsequently remelt the alloy. If you mix all your alloy ahead, as I do, you should use a bit more tin to be sure there is enough left in the alloy to provide good castings after subsequent remelting. I usually add 1/3 bar of 50-50 solder to a potful (11 lbs.) of wheelweights, which comes out to about 1 1/2% tin added to the basic wheelweight metal. This works very well for most pistol bullets and raises the hardness about one Brinell number.

A common mistake many bullet casters make is to cast with the metal too hot, or with the mold overheated. If you must heat your metal above 750°F to get good castings, you are doing something wrong.

I like to start casting with the metal around 700°F until the mold is heated enough to produce well filled out bullets, then I turn it back to the lowest temperature which produces good castings, usually about 625-650°F with my wheelweight and tin mixture. I always alternate between two molds, filling one and setting it down to let the sprue cool completely while I open and refill the other.

Good castings require you keep the

metal clean and fluxed. Otherwise, there is risk of getting dross into the mold if you are using a dipper, and you will otherwise lose alloying elements through oxidation. I like to flux about every 15 minutes, or whenever I add metal to the pot. Bullet lubricant or any wax will do. If casting outdoors where smoke is not a problem, I keep a few rejected lubed bullets and drop one in the pot once in a while to flux the alloy. Always scrape the sides and bottom of the pot well to dislodge impurities for skimming.

The basic technique of bullet casting is easily learned with a bit of practice and soon becomes natural. The mold must be clean and free of any oil or grease. I like to clean new molds by boiling in water with Ivory flakes or Oakite. Cleaning them in Cascade with an automatic dishwasher also works well. Remove the mold blocks from the hot water and shake dry, being sure they are completely dry before using them, since any latent moisture is potentially dangerous when combined with molten lead! To avoid constant recleaning and degreasing, don't oil your molds for storage. Store them in an air-tight container, wrapped in VPI paper to protect them from rust.

Resting your mold blocks on top of the furnace while the metal heats up helps preheat the mold, reducing the time necessary before getting good castings. I routinely reject the first 10 or so castings from each cavity, as it usually takes this many before the bullets come out perfectly filled and sharp. I knock the sprue and rejected bullets into a large wooden box for later remelting and to keep from littering the bench. Good bullets are dropped gently on a folded towel to prevent damage and are removed to a box as soon as they are cool so they aren't damaged by having subsequent bullets drop onto them.

As you fill the mold, overflow it to leave a large puddle, keeping the sprue liquid as long as possible to reduce shrinkage voids. Allow plenty of time for the sprue to harden, and never knock off the sprue until it is completely solid. Cutting off the sprue prematurely smears semi-molten metal across the blocks and bottom of the sprue plate and causes damaged, out-of-square bullet bases.

After knocking off the sprue, inspect the bullet bases before opening the mold. Any bullets with rounded, ragged, imperfect bases, or with pinholes which indicate a void underneath, should be rejected. Then open the mold, check the sides of the bullets, making sure they are clean, sharp and well filled out. Drop the best ones onto the towel in the "keeper" pile. When the pot gets down to half full, fill your mold and leave it to retain as much heat as possible then return the sprue and rejected castings to the pot. While waiting for these to melt, I again inspect the castings, looking for those with only minor imperfections which go into a "practice" box,

while those which are perfect go into the "match" box. Any with gross defects I missed before go back into the pot for remelting. In the time it usually takes to inspect the castings and sort them, the scrap is melted and the pot is ready for fluxing. Once the metal is fluxed and hot enough to pour freely, you are ready to start casting again, usually within five minutes.

After casting, the bullet must be sized and lubricated. Ideally, the bullet should cast perfectly round and the correct diameter. It should require very little or no sizing, the die only serving to true it up and rub the large spots slightly. It is best to slug your pistol barrel to determine the proper sizing diameter, but generally .45 ACP bullets should be sized .451", .38 Spl. bullets for semi-automatic pistols .357", and for most revolvers, .358". If you slug your barrel, size bullets no smaller than the groove diameter. It is best to size them .0005" larger, but not more than .001" larger than groove diameter, unless the mold casts very large. In that event, it is better to shoot a bullet which is somewhat oversized than to size it excessively. You should not size the bullet down more than .0015" from the as-cast diameter if you desire best accuracy. This is not always possible. Some molds may cast as large as .360" in .38 Spl. or .454" for .45 ACP, leaving you no choice but to shoot a somewhat oversized bullet.

At the lower velocities of target wadcut-ter loads used for .38 Spl. and .45 ACP, lubricant quality isn't usually a problem. But the best, most effective and economical lubricants to use are those based on a 50-50 mixture of pure yellow beeswax and Alox 2138F, as are sold by Javelina, Hodgdon, Lyman, RCBS, Tamarack and others. For the .38 Spl. with 2.7 grs. of Bullseye and wadcutters like the H&G No. 50, it is necessary to lube only the bottom grease groove to prevent leading and give best accuracy. Excess lubrication increases smoke, which can be particularly objectionable on indoor ranges, often impairs accuracy, and cruds up the gun more quickly. With .45 ACP bullets like the Lyman #452460, 452389, 45266, the RCBS #45-200SWC or the Saeco 290451, you similarly only need to lube the bottom groove with Alox if using moderate charges up to about 4 grs. of Bullseye or 4.5 grs. of Green Dot, or 5 grs. of W-W 231. If using less effective lubes like the old black Ideal lubricant or Saeco Lube B, you may need both grooves full to prevent leading. With bullets having a single large grease groove like the H&G 130, you may get slightly better groups with Alox lubricant using slightly heavier charges than the traditional 3.5 grs. of Bullseye.

Cast bullets can give fine accuracy for target shooting, but only if you exercise care in their casting, selection and preparation. If you have the patience to do the job right, you will find the expenditure of time worthwhile. — C. E. HARRIS ■

From The Loading Bench

Lyman Composite Bullet Kit

IN 1978, Lyman Products introduced kits for making composite pistol bullets for handgun hunting in .357 Mag., .44 Mag., and .45 Colt calibers. The three composite bullet designs, #358624 (170-gr.), #429625 (232-gr.) and #452636 (245-gr.) are Keith styles resembling the standard #358429, #429421 and #454424 bullets which are popular in these calibers. The composite bullets are intended to be used with the same load data as their conventional counterparts.

Composite bullets permit loading to full magnum velocities without leading because the rear "jacket" is cast of hard alloy, such as linotype metal, which resists deformation under the high pressures of magnum loads. Unlike conventional hard cast bullets, though, the composites expand reliably in magnum handgun loads. The front "core" is cast of pure lead, which is soft enough to expand easily at striking velocities above 1100 f.p.s. at normal handgun hunting ranges. These composite bullets offer handgun hunters a homemade alternative to expensive jacketed bullets, giving good expansion and penetration with excellent weight retention, while delivering accuracy comparable to conventional hard cast bullets, using the same loads.

The kit contains two single-cavity molds, one for casting the soft lead core and another for the hard lead jacket, plus a special top punch for sizing the jacket before cementing the core in place. Full instructions for assembling the bullets are included.



Sectioned #452636 .45 Colt composite shows its two-piece construction. #358624 and #429625 are made for .357 Mag. and .44 Mag.

Cores and jackets are cast of appropriate material, plumber's lead for the core and linotype metal for the jackets. Jackets may also be cast of wheelweight metal, sized and then heat treated to suitable hardness before cementing the core in place. This is done by placing the sized jackets in an oven at 425°F for one hour, then fully quenching them in room temperature water within three seconds. After about 10 days' age, these heat-treated jackets will attain hardness greater than linotype and will be suitable for full .357 Mag. or .44 Mag. loads.

Jackets are sized without lubricating them, then the base (small end) of the core is dipped in two-part epoxy and slipped into the jacket cavity. The two pieces should be rotated together to insure a uniform distribution of cement. Excess epoxy is wiped away without pressing the core into the jacket. Assembled bullets should be set aside for 24 hours before loading, to insure the epoxy has had time to cure fully. Then, composite bullets are lubricated in the usual way and loaded the same as conventional cast bullets.

In testing by the Technical Staff, Lyman composite bullets gave excellent accuracy, equal to carefully cast, conventional cast bullets, with good penetration and expansion, using water-soaked telephone books as a test medium. At low velocities around 1000 f.p.s. in the .45 Colt, expansion was



Wheelweight-metal Keith bullets don't expand. (Top): #454424 shot into wet paper at 1089 f.p.s. and #358477 at 1317 f.p.s. Composites expanded (bottom): #452636 at 1002 f.p.s., #358624 at 1247 f.p.s., #429625 at 1518 f.p.s., and #429625 at 1600 f.p.s. from T/C Contender pistol.

Loading Bench

not significant, although recovered bullets showed some flattening, and would probably be more effective than hard Keith type bullets. Expansion would be more reliable in higher velocity .45 Colt loads which are possible in Ruger Blackhawk or T/C Contender pistols. At velocities up to about 1200 f.p.s., the composite bullets perform like soft-points, the expanded nose portion remaining intact in a "mushroom" shape. Much above 1200 f.p.s., the expanded nose

shears away from the body, leaving the remaining core and jacket (about 80% of the bullet's original weight) intact to provide good penetration. This mechanism is very effective on game, provided the bullet retains at least 2/3 of its weight to attain adequate penetration, as the composites do. If the fragmentation is not wanted, however, use somewhat harder core material, such as 1:20 tin/lead or 3 lbs. wheelweights to 7 lbs. pure lead. This will raise the velocity at which expansion occurs to about 1300 f.p.s., and reduce fragmentation of the core up to about 1600 f.p.s. In high velocity loads above 1600 f.p.s. in the T/C Contender pistol,

ACCURACY RESULTS
Five Consecutive 5-Shot Groups At 25 Yds.

Test Firearm	Load Data	Vel. @ 15' (f.p.s.)	Smallest (ins.)	Largest (ins.)	Average (ins.)
.357 Mag. Ruger Security Six 4" bbl.	W-W case W-W 108 15 grs. W-W 296	1247	1.06	2.48	1.73
.44 Mag. T/C Super 14 14" bbl.	R-P case W-W 111 22 grs. #2400	1600	1.64	2.47	2.07
.45 Colt T/C Contender 10" bbl.	W-W case W-W 111 9 grs. Unique	1002	1.69	2.10	1.87
Average Extreme Spread					1.89

the jackets of some bullets fractured above the grease cannellure, though the epoxy bond between the expanded core and the remaining base of the bullets remained intact, and no core-jacket separations occurred.

Penetration of the Lyman composite bullets was approximately equal to that of jacket hollow-point factory loads of the same caliber. In the .357 Mag., .44 Mag. and .45 Colt test guns, they equaled the accuracy of factory loads. Although some bore leading was experienced in loads

above 1500 f.p.s. in the T/C Contender, accuracy was not impaired. Results of accuracy and expansion tests are summarized in the accompanying tables.

Although the composite bullets are more time consuming to make than conventional cast bullets, they are a highly practical, inexpensive alternative to jacketed handgun bullets. They offer a useful level of accuracy, penetration and expansion which is well suited to most handgun hunting purposes in the calibers for which they are suited. — C. E. HARRIS

EXPANSION TEST RESULTS
Averages of ten rounds shot into wet telephone books at 25 yds.

Test Firearm	Vel. @ 15' (f.p.s.)	Penetration (ins.)	% Weight Retained	Expansion (cals.)	Remarks
.357 Mag. Ruger Security Six 4" bbl.	1247	14	92	1.28	Three rds. shed expanded nose, but still retained 80% of original wt.
.44 Mag. T/C Super 14 14" bbl.	1518	19	80	1.08	Expanded noses shed as large fragments core and jacket intact jacket somewhat expanded
.44 Mag. T/C Super 14 14" bbl.	1600	14	72	1.20	Five rds. fractured mouth of jacket, but epoxy bond intact. Other 5 rds. shed nose and expanded jacket without fracturing
.45 Colt T/C Contender 10" bbl.	1002	14	99	1.00	Noses noticeably flattened, but no expansion above original bullet diameter

In My Experience

.25-20 Is Still Useful

Editor:

Many years ago, my favorite small game rifle was a Winchester Model 92 in .25-20 Win. It was retired only after its accuracy deteriorated from long use. Not too long ago, I bought a Ruger No. 3 in .22 Hornet for similar use on small game and varmints. I soon pondered on what a nice little small game carbine it would make if it was chambered for the .25-20 cartridge. That thought brought back many fond memories of my Winchester. A single-shot rifle has several advantages over a tubular magazine repeater, because pointed bullets may be used and cast lead bullets do not have to be crimped into the case. I decided to have my Ruger rebored to .25-20 with a 14" twist and a groove diameter of .257", which is standard for the .25-20 cartridge.

Winchester and Remington still load .25-20 ammunition with an 86-gr. lead bullet. The W-W 60-gr. jacketed hollow-point has been discontinued. In addition to these factory loads, I would be using the same handloads that I used in my Winchester 92.

I have two Lyman bullet molds for the #257420 and #257312, both flat point gas check designs. The former bullet weighs about 70 grs., and the latter about 85. Of the two, I prefer #257312 because I like its design with a crimping and two lube grooves. For use in my single shot, I lube all three grooves, and I do not crimp the bullets. I use two different handloads; one for hunting and the other for target shooting at the rifle range. For small game I use #257312 with a charge of 8 grs. of Hercules 2400, which is an accurate and adequate hunting load up to about 125 yds. For target use I load the same cast bullet but with 9 grs. of DuPont SR-4759. This is a fine target load with light recoil.

Light recoil and mild report are the main reasons why I like the .25-20. It is a pleasure to shoot at target or in the field without the muzzle blast and heavy recoil of some of the larger cartridges. This relatively mild cartridge is quite accurate and doesn't destroy edible meat like high velocity varmint rounds do.

I have a high regard for my new Ruger No. 3 and it has become my favorite. I use it more than any other gun I own.

JACK NOLAN, LAS VEGAS, NEV.

From The Loading Bench

Reinventing the "Manstopper"



Lyman #452626 composite jacket (l.) with 232-gr. cup-point wadcutter produced in same mould, after a simple modification.

HANDLOADERS have tried for years to get reliable expansion in low-velocity revolver loads. Few have been entirely successful. Even today's highly developed jacketed bullets usually require striking velocities around 1000 f.p.s. for reliable expansion. This isn't always possible within acceptable limits of chamber pressure in small, short-barrel revolvers, such as the various 2" .38 Specials or the Charter Arms .44 Spl. Bulldog. A further disadvantage of light-bullet, high-velocity loads is that they strike considerably lower on the target than standard-weight factory loads due to changes in barrel time and recoil.

The first truly successful expanding handgun bullet was the British .455" Mk. III "Manstopping Type" patented by William Thomas Webley in 1897. Despite its rather modest velocity of about 700 f.p.s., this 218-gr. hollow-based wadcutter, with identical nose cavity, expanded quite reliably. Its action was so effective that it was considered inhumane for use against "civilized" peoples. When a more effective cartridge than the round-nosed Mk. II with 265-gr. bullet was no longer needed for use against fanatical natives, the "Manstopper" cartridge was discontinued and the Mk. II again standardized.

Webley's cup-point bullet has been

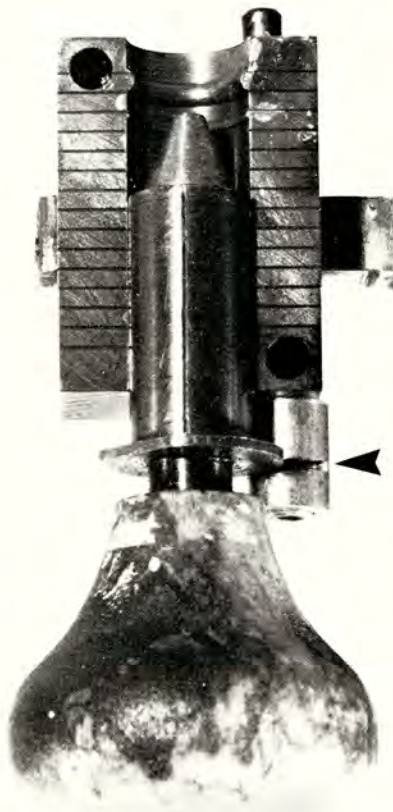

Bushing (arrow) permits base plug flange to be positioned farther out from blocks, making a heavier cup-point wadcutter slug.

copied in principle by shooters who inverted 148-gr. hollow-based wadcutters in the .38 Spl., in attempts to gain reliable expansion in short-barrel revolvers. This hasn't always been completely successful. (See *American Rifleman*, Oct. 1979, p. 18). Factory loads use similar bullets



#452626 cup-point bullets cast from 50-50 wheelweights and plumber's lead, and shot from M1917 S&W .45 Auto Rim (left to right) at 689 f.p.s., 767 f.p.s., 876 f.p.s. and 921 f.p.s. Use softer lead below 700 f.p.s., and limit velocity to about 900 f.p.s. in any case.

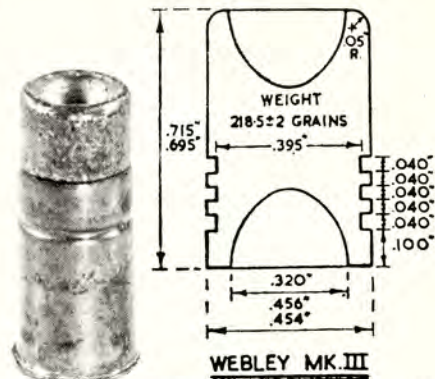

Webley's "Manstopper" bullet for the .455 dates from 1897. Eley cartridge ca. 1900 is similar to Mk. III military loadings.

have met with mixed success. (See *American Rifleman*, Aug. 1978, p. 59).

Today, however, handloaders have the means available to make effective, accurate, cup-point wadcutter bullets in .38, .44 or .45 calibers by making simple modification to the Lyman Composite Bullet Kit. These bullets expand reliably from short-barrel .38 Spl. revolvers or from larger caliber handguns in low velocity loads. The "jacket" mold for the Lyman composite has a conical cavity in the nose and a wadcutter shape, but if used in its existing form, the web between the nose cavity and base is too thin and will blow through upon firing, leaving a bore obstruction. However, if the base plug of the jacket mold is backed out about 1/4" from its usual position, it produces a heavier cup-point bullet with suitable strong base. This is easily accomplished by making a bushing of brass or mild steel, drilled through and counter-bored to accept a 6-48 screw to attach it to the blocks. A hacksaw cut on the side of the bushing positions the flange of the base plug during casting, as shown in the accompanying photo. The mold is readily converted back to its intended purpose, casting composite bullet jackets, by removing the bushing and screw and replacing the original base plug locating screw.

These modified bullets give good accuracy, equal to standard Keith-types, and can be tailored by choice of casting alloy to provide reliable expansion at velocities from 900 f.p.s. down to as low as 650 f.p.s. For loads above 850 f.p.s., wheelweight metal is best. Below 850 f.p.s. down to about 700 f.p.s. a mixture of wheelweights cut half and half with plumber's lead is better. For velocities, below 700 f.p.s., as in the .455 Webley, bullets should be cast of pure lead.

Extensive initial trials of the modified composite bullets were conducted with the #452626 composite jacket mold. The length of this bullet is limited to .63", if it is to be crimped in the existing crimp groove so as not to exceed the maximum overall cartridge length of 1.59" in the .45

Colt cartridge. This requires the base plug be backed out only .235", making a 232-gr. bullet when cast of wheelweight metal. This weight also shoots close to point of aim in fixed-sight M1917 S&W or Colt military revolvers which are regulated with .45 ACP M1911 Ball ammunition. Because of its cylindrical shape and long .452" bearing surface, this bullet cannot be chambered in the Government Model .45 pistol and therefore is suitable for .45 Auto-Rim, .45 Colt, or .455 revolvers only. When cast of wheelweight metal and shot in the .45 Auto Rim or .45 Colt, expansion is very good at velocities of 800 f.p.s. or more, though above about 900 in the .45 Colt, the expanded nose fragmented, leaving only the base intact. At 800 f.p.s. penetration in water-soaked telephone books averaged 6", compared to 16" for 250-gr. factory .45 Colt lead, flatnose bullets at similar velocities. Suggested powder charges are 5 grs. of Unique in the .455 Webley, 6.2 grs. of Unique in the .45 Auto-Rim, and 8.5 grs. of Unique in the .45 Colt. Heavier charges are neither necessary nor recommended.

This same modification works well in the .38 Spl., also. While the .45 tests were in progress, NRA Life Member S.H. Reed of Pine Grove, Calif., sent in some .38 Spl. cup-point bullets made by modifying a Lyman #358624 composite mold. Reed shortened the base plug .175", turning the cone of the base plug down to a sharp point, producing a 125-gr. bullet .58" long. In a brief test by the Technical Staff, Reed's bullets were loaded in new primed W-W .38 Spl. cases with 5 grs. of W-W 231 powder. Average instrumental velocity at 15 ft. was 893 f.p.s. from a Colt Detective Special with 2" barrel. When shot into water-soaked telephone books from 25 yds., these bullets penetrated 5½" and expanded to an average of .62" in diameter, without any appreciable weight loss.

The actual weight of the modified bullet can be changed at will by using a different length bushing. The only requirements are that the base be thick and strong enough to withstand discharge and that the nose not be so long as to exceed maximum overall cartridge length when crimped in the existing cannellure. In the .38 Spl., for instance, the base plug could be backed out as far as .38", giving a bullet .76" long, weighing about 170 grs. when cast of soft alloy.

For most purposes, however, a medium-weight bullet made by using a ¼" bushing to re-position the base plug is about optimum for modifying either the #358624, #429625 or #452626 composite molds. This permits the same bushing to be used for all, giving effective cup-point wadcutter bullets of approximately 140-grs., 200-grs., and 230-grs., respectively. Handloaders will find these bullets perform well in moderate loads using the same powder charges as for a solid lead bullet of the same weight. C. E. HARRIS

From The Loading Bench Unique Lives Up To Its Name



OVER the years I've tried to standardize on reloading components which serve a range of applications. While I still rely on a few specialized powders for the exacting requirements of bench-rest and target shooting, most practical hand-loading needs are served by only one or a few.

Although I have flirted with almost every propellant under the sun, nearly all my reloading today is accomplished with just three powders: W-W 760, IMR-4895 and Hercules Unique. The only exceptions are specialized loads for the Contender handgun, which seems to favor IMR-4227 over anything else.

Of all these powders, Unique gets the most use by far. If I had to limit myself to only one, Unique would be it. It serves admirably as a handgun and shotshell powder and does very well for reduced loads in almost any rifle cartridge. Though it isn't suitable for big game rifle loads, it will do for practice, small game, and plinking. I wouldn't feel at all handicapped buying factory cartridges for the few rounds I actually shoot at big game.

Unique is probably the best powder for 20-ga. skeet and field shotshell loads, and I shoot more of these than any others. There are better 12-ga. powders, but Unique does OK for these, also. I save money by using only one powder for all my shotgun, handgun, and rifle small game loads. A shotgunner who does only 12-ga. shooting, however, would do well standardizing on Du Pont 700X or Hercules Red Dot for all his shotgun and handgun loading, provided he is satisfied only with light target loads for the latter. I know several shooters who do just that. It sure beats using several powders to do those jobs.

In my 20-ga. guns, I shoot 16 grs. of Unique as a standard charge with 7/8 oz. of shot in AA or RXP target shells, or with 1 oz. of shot in Federal Game Load hulls, by choosing the appropriate wad and primer from listed sources of data. In the 12-ga., a charge of 20-22 grs. gives a three-drams equivalent 1-1/8 oz. load with a variety of primers, wads, and cases listed in the *Hercules Reloader's Guide*.

When it comes to handgun cartridges, few handloaders will dispute that Unique does a great job. Although you give up a bit in performance with the magnum loads, you can approach factory levels close enough to make little practical difference. For most practice and silhouette shooting, a safe, full-charge load of Unique does about as well as a full-house, hand buster of W-W 296, Blue Dot, or IMR-4227. By standardizing on one powder, however, you save money, and for giving up the small bit of velocity, you often have a more-accurate, lower-recoiling load you can shoot better.

I have found myself using only a few specific charges of Unique for a variety of cartridges. I use 8.0 grs. of Unique as a full-charge load with a 154-gr. hard-cast Lyman #358477, or 158-gr. jacketed bullet in the .357 Mag. These are both very accurate. The 8-gr. charge also gives a stout 1000 f.p.s. load in the .45 ACP with a 185-gr. jacketed bullet, and it approximates the factory loading in .45 Colt with a 250-gr. cast bullet. In the .44 Mag., it gives a mild and accurate practice load with a 240-250-gr. cast lead bullet. That same 8-gr. charge gives good results with 200-220-gr. bullets in the .44-40 revolver.

The 8-gr. setting of Unique on the measure isn't used just for handguns, but serves as an accurate and reliable, non-

destructive small game or turkey load in a variety of rifle calibers. In the .223 Rem., it gets 2100 f.p.s. with a 55-gr. jacketed bullet, and in the .250 Savage, about 1400 with a 100-gr. soft-point. In my .30-30, it shoots to the iron sights at 25 yds. using my normal 100-yd. factory load zero and a 150-gr. flatnosed bullet. It punches a neat hole through small game at about 1350 f.p.s. In the .35 Rem., that same charge works well with 158-gr. .357 Mag. jacketed bullets for about 1300 f.p.s. I suppose you could find 8 grs. of Unique works well in a lot of other guns, too, but these are all I've had the chance to try yet.

Unique powder is used most in my other handgun and many midrange rifle loads, too. My favorite medium-velocity .357 Mag. silhouette load uses either the Lyman #358429 or the Sierra 170-gr. FMJ with 6.5 grs. of Unique, for about 1000 f.p.s. That same charge is also excellent with almost any 200-230-gr. cast or jacketed bullet in the .45 ACP. With the 230-gr. hardball bullet, it very closely approximates the military load. My favorite fun-shooting load is 5.0 grs. of Unique in the .38 Spl., with the Lyman #358477 or 158-gr. Taurus bullets. This load falls neatly between a standard velocity factory load and a +P and has shot well in every .38 revolver in which I have used it. It is about the most you can shoot in a small-frame .38 on a regular basis. In my heavy-frame .38 Spl. or .357 Mag. guns, I use 5 grs. of Unique with the 176-gr. NEI Keith-style bullet, which gives me a slightly higher point of impact for 50-yd. shooting in fixed-sight guns.

Light charges of Unique are suitable for small game loads with cast bullets in most center-fire rifles. You shouldn't try for very high velocities, though, since this fast powder reaches peak pressure rather quickly. A great source of data for Unique with cast bullets in most rifle cartridges is the new *Lyman Cast Bullet Handbook*. Unique works well for jacketed bullets also, though it requires some caution. If you attempt to load below about 1300 f.p.s., you risk lodging a bullet in the bore. For really light loads, you should use a cast lead bullet. Small charges leave a lot of air space in the case, so you must carefully check each case to double-check against multiple charges or rounds with no powder.

Some of the most accurate small game loads I've used were in .35 cal. rifles with 6 grs. of Unique and a .38 Spl. HBWC bullet seated out to just touch the rifling. Now that .32 S&W wadcutters are available for handloaders, .30 cal. rifle shooters can do it too. A charge of 5 grs. of Unique and a 100-gr. Taurus wadcutters will shoot ½" groups from a .308 or .30-06 at 25 yds. if started into a case well flared with a Lyman M die to prevent damage and seated out to touch the rifling. At about 1000-1100 f.p.s. they are very effective small game loads.

Buckshot or the swaged round balls

sold for muzzle-loaders also work well for light plinking or small game loads in appropriate calibers. The loading technique here is different though. The ball should be somewhat oversized so it will squeeze down on entering the rifling so it will hold in the lands and not strip in the bore. A lead ball should be about .005" over groove diameter and pressed snug into an *unsized*, primed and charged case. Smear a little grease or bullet lube over the case mouth to lubricate the ball. A #0 buckshot (.32") shoots well in most .30 cal. rifles, and #000 works in .38/.357 revolvers and .35 cal. rifles. For .44 or .45 cal. rifles and revolvers, you can get appropriately sized swaged balls from Speer or Hornady, and load them the same way. Or you could cast your own.

All things considered, it's hard to imagine any other powder with which a fellow could get so much shooting in so many different guns. The name Unique fits pretty well.—C. E. HARRIS

REDUCED UNIQUE RIFLE LOADS			
Caliber	Bullet Wt. (grs.)	Unique (grs.)	Approx. Vel. (f.p.s.)
.22 Hornet	40-45 CAST	3.0	1300
	40-45 SP	4.0	1500
.222 Rem.	40-45 CAST	4.0	1300
	50-55 SP	7.0	2000
.223 Rem.	45 SP	6.0	1900
	50 SP	7.0	2000
	55 SP	8.0	2100
.22-250	55 SP	9.0	2000
.220 Swift	55 SP	10.0	2000
.243 Win.	#3 Buck	5.0	1300
	87 SP	10.0	1700
6 mm Rem.	#3 Buck	5.5	1300
	100 SPRN	10.0	1600
.250 Sav.	100 SPRN	8.0	1400
.257 Robt.	100 SPRN	10.0	1450
.25-'06	100 SPRN	12.0	1700
.270 Win.	130 SP	12.0	1500
7x57	140 SP	12.0	1450
.280 Rem.	140 SP	14.0	1500
	100 HBWC*	4.5	1100
	150 SPFN	8.0	1350
.30-30	170 SPFN	9.0	1400
	100 HBWC*	5.0	1100
	150 SPFN	10.0	1500
.308 WIN	170 SPFN	10.0	1400
	100 HBWC*	5.5	1100
	150 SPFN	12.0	1600
.30-'06	170 SPFN	12.0	1500
	#00 Buck	6.0	1200
	170 SPFN	12.0	1600
8x57	148 HBWC**	6.0	1100
	158 SPFN	8.0	1300
	200 SPRN	10.0	1400
.35 Rem.	240 SPFN	15.0	1400
	.433" RB	6.0	1000
.444 Marlin	240 SPFN	15.0	1400
	.460" RB	7.0	1000
	300 JHP	15.0	1400
.45-70	405 SP	15.0	1250
	.460" RB	10.0	1200
.458 Win	405 SP	19.0	1300

*Taurus 100-gr. HBWC for .32 S&W Long

** .38 Spl. hollow-based wadcutters

In My Experience

Squib Loads

Editor:

During the long, snowy winter months, when I am unable to shoot outdoors, I load cast bullets for my Winchester .32-40 High Wall and .308 M70 Target rifles for offhand practice in my basement.

These ultra-light loads are pleasant to shoot and are easy on the ears even when not wearing ear protectors. The bullets are mostly rejects which I would not use in serious outdoor target and bench-rest shooting.

The charge for both rifles is 2 grs. of 700-X shotgun powder with the CCI Large Pistol primer. This small charge propels the 170- and 180-gr. cast bullets to the target 40' distant with deadly accuracy. For this low velocity, any lube will do. I use a 50-50 blend of paraffin and Vaseline.

In the High Wall .32-40 single shot, I seat Lyman bullet #321232 in the bore with a lead pencil or piece of dowel. This wedges the bullet into the throat and prevents it from falling back into the unsized charged case which follows it. There is no need for a reloading tool other than some decapping and priming arrangement. The cases are never sized, and brass life is indefinitely long.

In the Winchester .308, I use Lyman bullet #311291 without a gas check. This bullet casts .311" and is not sized. I select five unsized fired cases whose neck thickness allows a snug fit of the bullet when it is inserted with the fingers. The bullet is set into the charged and primed case about one band deep. Closing the bolt completes the seating, leaving the bullet just touching the lands.

I use no wads or filler to keep the small powder charge in place. Instead, I elevate the muzzle of the rifle to position the powder. For safety reasons, elevating the muzzle is done only with the action open, and the rifle is cocked only when the sights are on target.

I find the preparation and shooting of these squib loads very enjoyable, and am thereby able to keep my offhand shooting muscles in trim. An old Detroit Bullet Trap stops the bullets, and I eventually recast the spent lead.

P. FYNE, TORONTO, ONT.

From The Loading Bench

Handloading For .44-40 Revolvers



Colt's Frontier Six Shooter in .44-40 was the standard trail gun of its day. It was compact, rugged, accurate, suitably powerful, and fired then-common ammunition. It was as basic in the 1880's as the .357 Magnum is today, and just as useful.

THE .44 W.C.F. or the .44-40 Winchester has been a favorite of mine for many years. I have shot thousands of .44-40 cartridges, both factory and handloads, in my Colt Single Action Army revolver. The .44-40 should be handloaded with a cast lead bullet sized to the groove diameter of the barrel that it is to be used in if one wants to have the most accurate load for his particular gun. Jacketed bullets have never been as good in this respect for me.

Factory .44-40 cartridges are loaded with a 200-gr. jacketed soft-point bullet and a light charge of smokeless powder which can be safely used in revolvers and the Winchester Model 1873 rifle. Velocity of factory loads is about 1300 f.p.s. from a 26" barrel rifle, about 1240 f.p.s. from a 20" carbine, and 920 f.p.s. from a 7½" revolver. The old high velocity load for the 1892 Winchester gave 1565 f.p.s. with this same bullet. It must never be used in blackpowder rifles or in ANY handgun, due to its higher pressure. I've found factory .44-40 ammunition suitably accurate, but prefer handloaded ammunition with cast lead bullets, as they can be assembled inexpensively and are often more accurate than the factory rounds. They are also more versatile, as different bullet weights are available to the hand-loader.

I have used three different Lyman cast bullet designs successfully. The Lyman #42798, 205-gr. flat-point, plain-based bullet is the standard one for this caliber. It copies the original factory lead bullet

used in blackpowder days and is quite accurate, with suitable loads. I have also used the Lyman #429360, a plain-based 232-gr. semi-wadcutter, designed by Gordon Boser for the .44 Special. I like this one a lot. Later I used Lyman #429215, a 215-gr. gas-checked semi-wadcutter bullet designed by Ray Thompson. This is a very accurate bullet. For target practice or plinking, I use 5-grs. of Bullseye powder with all three bullets. For hunting, I like 8.5 grs. of Unique, but still prefer a case full of Du Pont or GOI FFg blackpowder, poured into the case to just above the base of the bullet so that when the bullet is seated in the case it will compress the powder charge. This is a safe, but powerful load, giving nearly 1000 f.p.s. in a 7½" revolver. All bullet weights are based on a 1:16 mixture of tin to lead, lubricated with Lyman lube and sized to .427" diameter. All cases should be full length resized and the cases roll crimped onto the bullets, to prevent their creeping forward under recoil.

The above smokeless powder loads should not be used in revolvers that were made for blackpowder ammunition.

The biggest mistake that one can make in handloading for the .44-40 is to try and make a high velocity cartridge out of it. If you want "magnum" performance, buy a .44 Mag. Neither the .44-40 case nor the firearms chambered for it are particularly strong by modern standards. Many balloon-head cases are around, which are dangerous if used with high pressure loads. If clean and sound, and not

corroded by blackpowder residue, they are OK for light target loads, though I use only solid-head cases for my full hunting loads with 8.5 grs. of Unique.

The big advantage in using cast lead bullets in the .44-40, besides being cheaper than factory ammunition, is that they cause less wear to the barrel. Early .44-40 barrels are made of mild steel, and if jacketed bullets are used they will wear out a barrel fast. I once completely shot out the barrel of an old Colt until it was almost smooth inside when I finally had it rebarreled.

I have owned three Colt Single Actions in .44-40 cal.; one in 5½" and the other two in 7½" barrel lengths. The 7½" is by far the best choice.

Despite the fact that the .44-40 Winchester cartridge is 106 years old, it doesn't mean that it has to be put aside today. In a good late model Colt or Smith & Wesson revolver, with properly assembled handloads, the .44-40 is a good choice for target or hunting use and a lot of fun to shoot. Some .44-40 enthusiasts have converted modern .44 Mag. revolvers to shoot .44-40 ammunition to have companion revolvers for their rifles, rather than altering increasingly scarce .44-40 rifles to the .44 Mag. This makes a lot of sense to me. The recent availability of modern replica revolvers and carbines in .44-40 should also give this fine cartridge renewed life.

— JACK NOLAN

Editor's Note: The .44-40 cartridge was probably the first rifle cartridge that was successfully adapted to handgun use. Introduced for use in Winchester's Model 1873, lever-action rifle, the .44-40 enjoyed considerable success long before Colt began chambering their Single Action Army Revolver for it.

Once started, Colt made the most of the .44-40's popularity. From its inception in 1878, until production of all Single Actions ceased at the start of World War II, Colt made over 71,000 .44-40s.

Not that the Winchester 1873 and Colt Single Action were the only guns made in .44-40; far from it. Between 1884 and 1902 Colt sold its Lightning Magazine Rifle, chambered, among other calibers, for the .44-40. Winchester added the Model 1892 lever-action to its line in that year, and kept the model in production until 1941.

Up to the present everyone who is anyone, it would seem, has made or sold a .44-40. Remington provided its 1875 and 1890 Army Model single-action revolvers and one version of its rolling block rifle in .44-40. Smith & Wesson offered both single- and double-action revolvers for the cartridge. Lesser known makers like Merwin, Hulbert & Co., and Forehand and Wadsworth turned out all the .44-40s they possibly could. More recently several importers have sold reproductions of the Henry rifle and of Winchester models of 1866 and 1873 in .44-40.



.44-40 cast bullets are (l. to r.) #42798 205-gr. FN; Boser Special #429360, 232-gr. SWC; Thompson #429215, 215-gr. SWC.

Questions

&

Answers

Deep Seated Cast Bullets

Is there any harm in seating gas-checked cast bullets so the bullet base is below the neck? I have been told this is harmful, but am not sure why. When shooting long, heavy bullets in my .308 Win. rifle, I must seat the bullet base below the neck, otherwise the bolt won't close. Is there any other way around this?

Answer: Although deep-seated cast bullets sometimes give acceptable accuracy, performance of such a load depends upon several factors. With soft alloy, and particularly with relatively fast-burning powders such as SR-4759 or IMR-4227, the base of the bullet upsets significantly before the bullet moves forward into the chamber neck and throat. The enlarged bullet base must then be squeezed down as it enters the neck and forcing cone, which causes further bullet deformation and often raises pressures as well. These factors do not contribute to good accuracy.



Deep seated bullet shows gas cutting and shed its gas-check. Correctly seated bullet retained gas-check without gas cutting.

With harder bullets, the hot powder gases wash lead away from the exposed sides of the bullet not sealed off in the chamber throat and bore. This often causes leading in the rifling origin, and hurts accuracy. Gas cutting can also result from undersized bullets in otherwise correct loads.

To illustrate this condition, two Lyman #311284 linotype bullets were shot into wet paper at a velocity of about 1700 f.p.s. and recovered. The bullet which still retains the gas-check was seated so that its

base was flush with the bottom of the case neck. The other bullet was fired with the same load, but with the bullet base 1/10" below the neck. It shows obvious gas cutting of the lowest driving band and the region immediately above the gas-check. This weakened the attachment of the gas-check, causing it to come off in flight.

There may be better solutions to your problem than deep seating your bullets. If the diameter of the bullet nose or exposed driving bands are greater in diameter than the bore and chamber throat, the bullet will resist chambering. If examination shows that chambering raises a burr on the front band (see *American Rifleman*, Oct. 1978, p. 72), sizing the bullet slightly smaller (though never smaller than groove diameter) or carefully enlarging the chamber throat by polishing, will often correct the problem. If the bullet nose is marked forward of the bands by the lands and is pushed back in chambering, use of a slightly softer alloy will reduce the resistance, due not only to its lesser hardness, but to its greater shrinkage which causes it to cast somewhat smaller. With most production molds, oversized bullet noses are not a problem. Some .30 cal. bullets, however, such as the Lyman #311299, have large-diameter bore riding portions, which are a tight fit in some barrels.

If the amount of interference in your chamber is more than can be compensated for by minor changes in bullet sizing, or increased neck tension to resist pressing the bullet deeper in the case, you must make adjustments elsewhere. While serious cast bullet target shooters may alter chambers to accommodate a desired bullet, the average shooter can usually get satisfactory results simply by changing to a bullet which fits his chamber better, at normal seating depth. — C.E.H.

Paper Patched Bullet Tips

I have been having problems obtaining accurate loads with the paper-patched .30 cal. bullets described by Col. E. H. Harrison in the NRA book Cast Bullets. I cast the #301618 bullets of wheelweight metal, patched them with Crane Bond, sprayed with TFE dry film lube, sized them to .308" and wiped off the excess Alox. My .308 Win. rifle will group under an inch at 100 yds. with jacketed loads, but my paper-patched groups have been three times that. I have used various charges of H335 and H380 powder. What am I doing wrong?

Answer: In our experience, the 160-gr. #301618 bullet you have has never proven quite as accurate as the heavier #301620, but if your rifle has a very short throat, the lighter bullet may be the only one suitable, as the .308 has a relatively short neck.

Your bullet metal is only about 12 BHN, which is probably too soft for good results above about 1800 f.p.s. It is necessary that the bullet be seated out to press against the forcing cone of the rifling, since these paper-patched bullets cannot tolerate any jump. A soft bullet would accentuate any deformation from that cause. As Col. Harrison's articles state, the patch must be fitted to the rifling origin, by sizing and adjusting the amount of patch exposed, so the patch is not torn upon discharge.

If you are jumping the bullets into the rifling, and casting them too soft, that would explain the poor accuracy. If the bullets are only somewhat soft, but fit the throat well and are properly guided into the rifling, they should shoot reasonably well, but not as well as bullets of correct hardness. Bullets which are too hard will shoot wildly in loads too light to upset the bullet.

The patch should be sized .308" to easily enter the forcing cone so it will not be pinched or torn. The beginning of the bore-riding nose portion of the bullet should be lightly engraved upon chambering by the rifling. Any additional engraving which doesn't damage the patch, or result in pulling the bullet when you extract the round, does no harm. Please try again, with well-cast bullets of somewhat harder alloy, seated and patched to fit the throat snugly. You should do better then.—C.E.H.

Tin-Based Babbitt Metal

I purchased a bar of metal advertised as tin. Markings on the bar indicate that it is a nickel-tin alloy called Tuftin, manufactured by Jackson Wheeler Metals, Inc., Brooklyn, N.Y. Can this alloy be used in casting lead bullets?

Answer: Tuftin refers to any one of a group of lead-free, tin-based Babbitt alloys. According to the 8th edition of the Metals Handbook, published by the American Society for Metals, lead-free tin Babbitts typically contain 4% to 8% antimony, 3% to 8% copper and less than 1% of other minor additives. Tuftin reportedly

contains some nickel which has a function in the alloy similar to that of copper. The Babbitt is best utilized by adding it directly to pure lead or wheel weights, and while the copper and/or nickel content is excessive for cast bullets, the concentrations of these elements can be reduced during alloying.

With the pot adjusted to normal casting temperature, about 750° F, add the desired quantity of tin Babbitt to your lead alloy, then stir, flux and skim the pot as usual. Now turn the pot temperature down to about the melting point of lead, 621° F. It is preferable to use a thermometer for this, but if one is not available, the appropriate setting can be determined beforehand by adjusting the pot to just keep plumber's lead molten. As the melt slowly cools, the solubility of copper will diminish and small crystals of a copper-rich intermetallic compound will rise to the surface, giving the melt a lumpy appearance. Do not stir or flux, but periodically skim the surface to remove these lumps. When the temperature of the melt finally stabilizes at the melting point of pure lead, the copper content will be approximately 0.1%; the exact level will depend on alloy composition and how thoroughly the melt was skimmed.

Properly done, the above procedure takes a little time and patience, but it is easily justified, considering the current price of tin is pushing \$8 per pound. — D.L.M.

Foundry Type Metal

A printer friend gave me some "foundry metal" type which has the numbers and characters cast onto individual blocks. I wish to use this for casting bullets. Based on the compositions given in the Metals Handbook, it would appear that a mixture of three parts wheelweights to two parts foundry metal should have a composition similar to linotype metal. Would this be practical?

Answer: Foundry type is entirely suitable for preparing bullet casting alloys. The ninth edition of *Metals Handbook*, Vol. 2, lists three compositions for

Kind	Compositions of Foundry Type According To The Metals Handbook				Liquidus Temp.
	% Antimony	% Tin	% Copper	% Lead	(Without Copper)
Hard (1.5% Cu)	25	13	1.5	60.5	617° F
Hard (1.5% Cu)	20	20	1.5	58.5	574° F
Hard (2.0% Cu)	25	12	2.0	61	619° F

foundry type. These are shown in the accompanying table.

For all practical purposes, the first and third compositions are identical. Discounting the presence of copper, both alloys begin to solidify at approximately 618° F (liquidus) and are completely solid at 464° F (solidus). The second composition containing 20% each tin and antimony begins to solidify at 574° F and is completely solid at 464° F. At temperatures just above the liquidus for each alloy, only part of the copper will be dissolved in the melt. The remainder will be floating near the melt surface in the form of copper-rich crystals of an intermetallic compound, $Cu_2 Sb$. Existing information on the mixing of copper with lead-antimony-tin alloys is not very precise, but it is estimated that the temperature would have to be raised to more than 850° F to dissolve all the copper.

The limited solubility of copper can interfere with casting from a bottom-pour pot. The pour spout generally operates a little cooler than the bulk of the melt, and there is a tendency for the copper-rich crystals to precipitate in the spout and choke off the flow of metal. This problem is sometimes encountered in commercial casting machines.

On the other hand, limited solubility can be used to the bullet caster's advantage to reduce the copper content. The solubility of copper in lead is very dependent on temperature and the amount of antimony in the alloy; lowering both will minimize the solubility of copper, causing the copper-rich crystals to segregate to the melt surface where they can be removed by skimming.

The mixture you suggested, three parts wheelweights to two parts foundry type, is just about ideal for any of the compositions listed in the table. Melt the wheelweights first at about 650° F, then add the foundry type and stir the melt. Now turn the pot temperature down to about 500° F. If you don't have a thermometer, adjust the temperature control to just keep the alloy fully molten. Allow the pot to remain at this lower temperature for about 15 minutes without any disturbance, then gently skim the surface. Return the pot to normal temperatures, and you're ready to cast.

Depending on the composition of your foundry type, the mixed alloy will contain 5% to 8% tin and 10% to 12% antimony, with casting characteristics similar to linotype. An added benefit is that the hardness will range as high as 30BHN (compared to 22 for pure linotype), owing to the presence of arsenic from the wheelweights. — D.M.

Cavity Quality



Wire section holds insert in place above propane torch. This allows insert to be heated to necessary higher temperatures.

No matter what I do I cannot get good bullets or slugs from .357 hollow point or 12 ga. hollow based moulds. I have tried boiling the blocks in detergent, smoking the cavities, running my furnace to 850°, and I am finally out of tricks. Do you have any?

Answer: The big problem with hollow point and hollow based moulds is that the insert which is used to form the cavity has to be removed from the casting before the bullet can be dropped from the blocks. This removal allows cooling that is more rapid than that of the blocks which have significantly more mass. Despite rapid casting and high furnace temperatures, the insert cannot always be brought up to a sufficient temperature to allow molten lead alloy to form around it. As a consequence, there are voids and wrinkles found in the portion of the bullet that contacts the insert.

A solution to the problem involves using a propane torch with a section of wire wrapped around the tip. The HB or HP insert can be set in the flame of the torch while dumping the bullet and making the mould ready for the next cast. — E.L.

For more information about the Cast Bullet Association, Inc. write Secretary:

**Ralland Fortier
14193 Van Doren Rd.
Manassas, VA 22111**